

ROLLER CHAINS

SOLID BUSHINGS & ROLLERS



ZEXUS CHAIN Co., Ltd.



Roller Chains

As a comprehensive chain manufacturer, we produce Roller Chains, Conveyor Chains, Cast Chains and many other types of chains.

We provide a full range of manufacturing processes from machining through heat treatment for assembly based on our experiences and technologies accumulated over more than 100 years.

We are proud that our products keep contributing to industrial progresses in Japan and abroad.

Caution

We take great care in manufacturing chains, sprockets and other products shown here.

Nevertheless, errors and shortcomings in the selection, handling and maintenance of these products can cause chains to break or be damaged, potentially leading to severe accidents.

The selection, handling and maintenance of chains and sprockets must be performed carefully, with close reference to design documentation, selection criteria and instruction manuals.

If you are uncertain of any point concerning these products, please contact us for advice and information.

Solid Bushing and Roller Chain outlasts Conventional Roller Chains

In 2009, ZEXUS went into full production of the new Solid Bushing and Roller Chain across the standard range. ZEXUS once again were the front runner and introduced new innovations in manufacturing technologies and part processing which has led to the development of the new Solid Bushing and Roller Chains. New Solid Bushing and Roller Chain now offers up to 30% increase in Maximum Allowable Load (MAL) compared with leading competitors.

Comparison Table of Maximum Allowable Load

ANSI	Competitor (kN)	ZEXUS (kN)	BS	Competitor (kN)	ZEXUS (kN)
35	2.16	2.48	08B	N/A*	3.14
40	3.63	4.17	10B	N/A*	4.90
50	6.37	7.22	12B	N/A*	7.06
60	8.83	10.70	16B	12.60	16.40
80	14.70	19.10	20B	19.60	25.50
100	22.60	29.40	24B	27.50	35.70
120	30.40	39.50	28B	34.30	44.50
140	40.20	52.30	32B	39.20	51.00
160	53.00	69.00			
180	60.80	79.00			
200	71.60	93.00			
240	99.00	129.00			

30% UP!

*NOTE:Published data is not available

30% UP!

Fundamental Structure of Solid Bushing & Roller Chain

Outstanding longer wear life

Conventional split bushings deform into a barrel shape when side plates are pressed on, leaving only two-point contact area. Solid Bushing & Roller Chain has extremely cylindrical inside and outside bushing walls resulting in full contact to disperse bearing pressure. Less pressure ensures excellent wear resistance.

Up to 2-3 times longer wear life over curled bushings

The curled, split bushings have a seam where tiny space allows lubricant leakage resulting in shorter wear life. Solid Bushing & Roller has no seam resulting in lower bearing pressure allowing the bushings to retain lubrication resulting in much longer wear life.

Reliable performer

Solid Bushing Roller is cold-forged from steel rod. Cold-forming process also works with the molecular structure (grain) of the steel running lengthwise in the bushings thereby increasing fatigue strength as well as preventing bushings from breakage, Solid Bushing Roller Chain improves performance of transmission with minimizing elongation for long period of time.

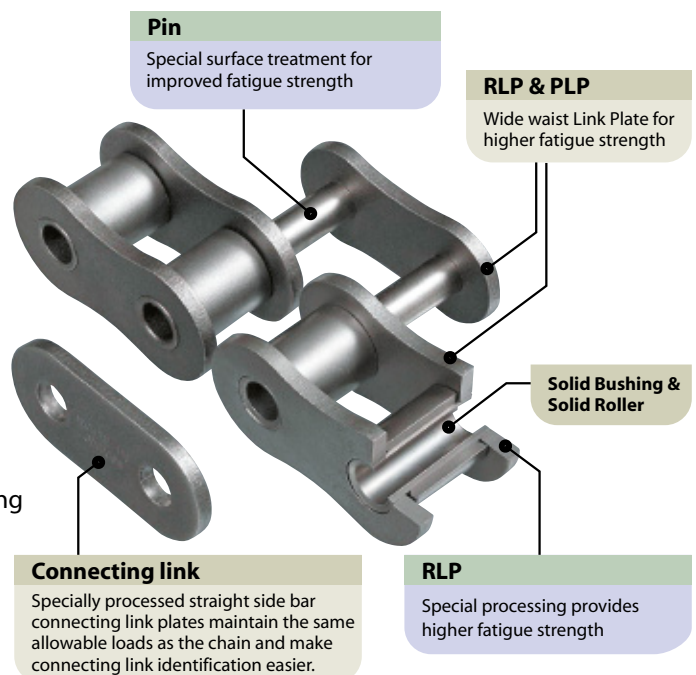

Mechanism of how Solid Bushing & Roller Chain supersedes other competitors for more than 30 years

Solid Bushing & Roller Chain

Before Assembly After Assembly

Solid bushings with tapered ends assure near perfectly straight ID surface after assembly. The ends collapse due to press fit resulting in ultra straight bearing surfaces.

Conventional Chain

Before Assembly After Assembly

Bushing ID becomes barrel shaped as a result of press fit and makes uneven contact between pin and bushing.

Wear Resistance

Solid Bushing & Roller Chain shows HIGHER wear resistance

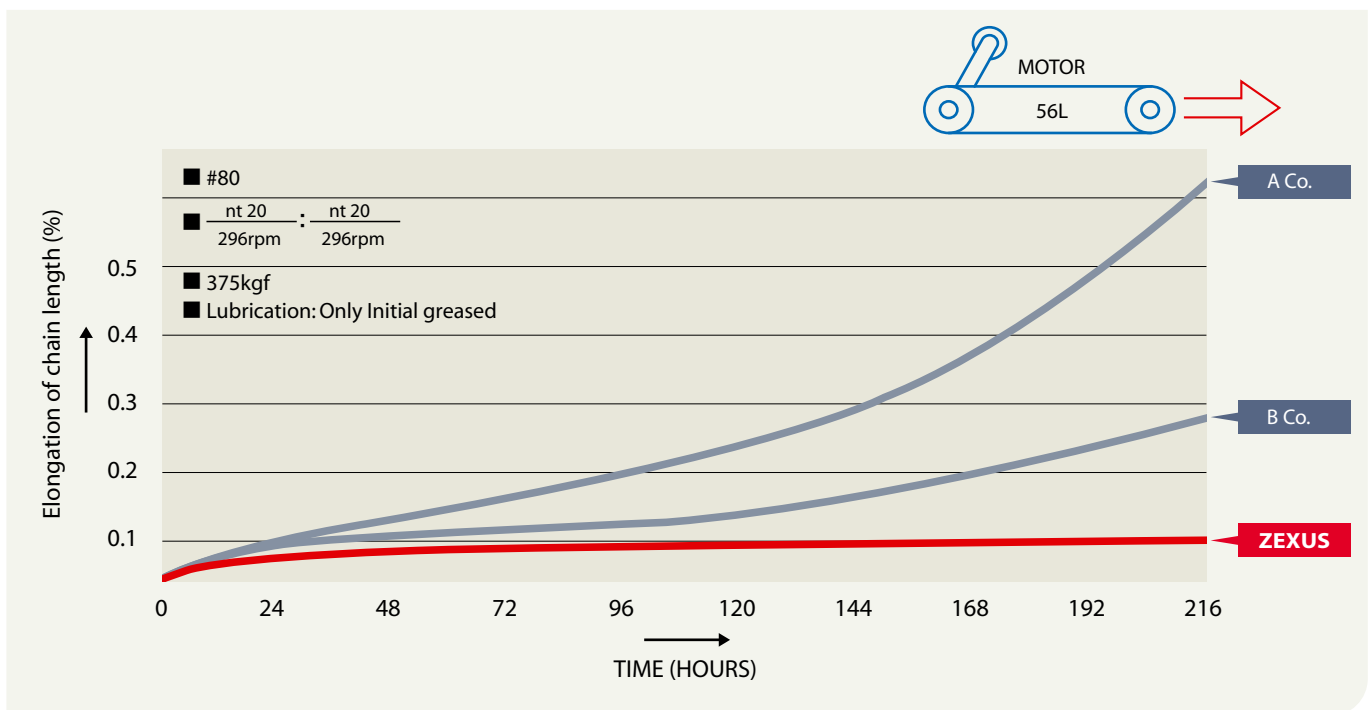

CF Series SBR Roller Chain

BRAND-NEW Chromium Free Roller Chain

Custom formulated CF coating delivering ecological advancement and significant improvements in wear resistance.

Built on the solid foundation of ZEXUS Roller Chains original premium quality.

Features

PROTECT from WATER

CF Series Roller Chains are coated in parts before assembly and offer the user the high corrosion resistance. Where roller chain is exposed to nature's rugged elements including rain, salt, sun and wind the CF Series Roller Chain will ensure the longest available service life.

CHROMIUM FREE

Environmentally friendly surface treatment without trivalent or hexagonal chromium content.



■ Caution must be taken where abrasion can cause the surface coating to be removed.

Comparison chart of corrosion resistant

Salt Spray Test[®] Results

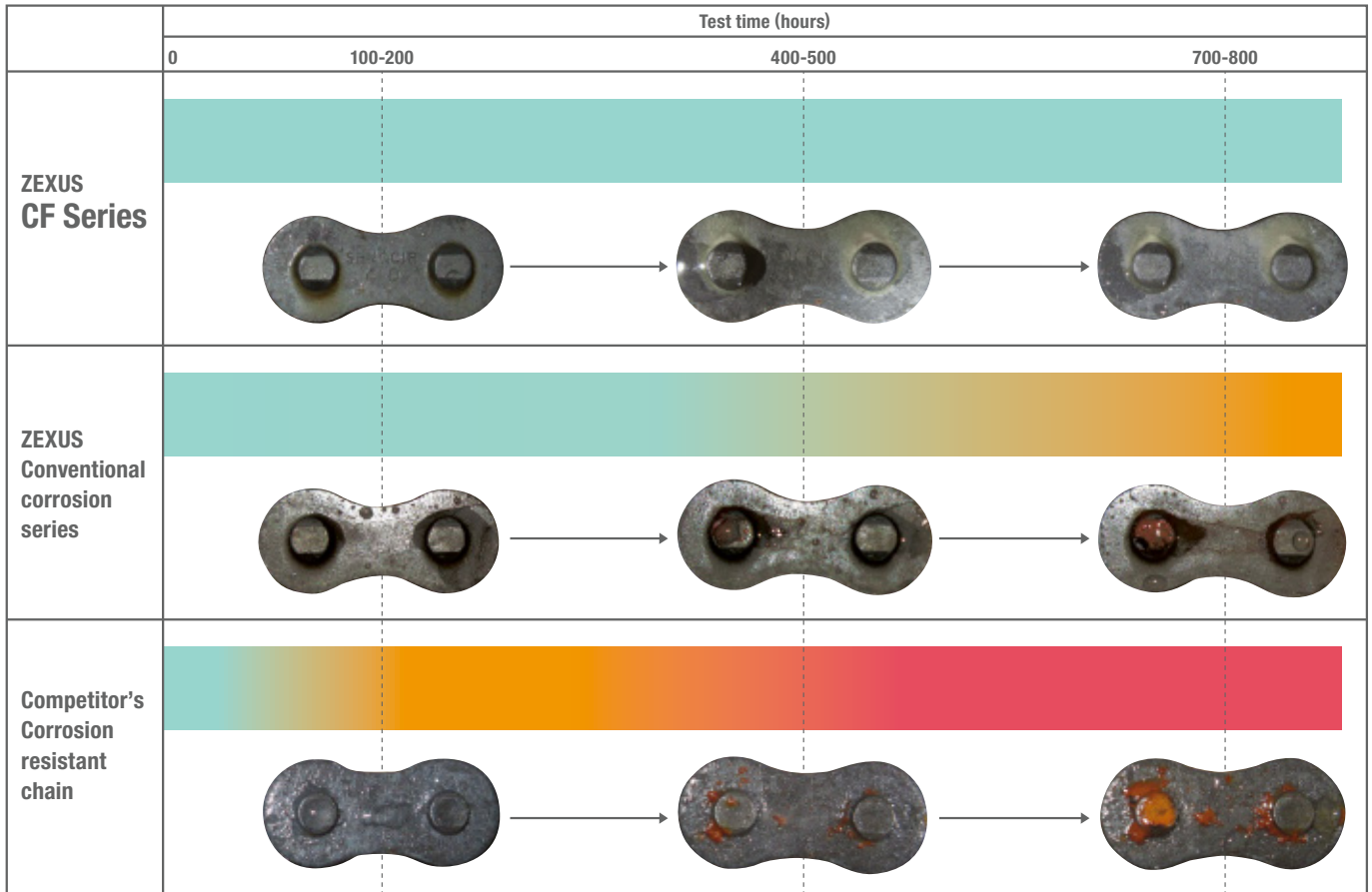

(*) Salt Spray Test according to JIS Z 2371

Chain Dimensions

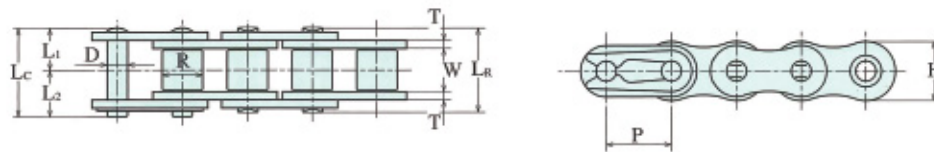

	Chain No.	Dimensions - mm										Average Ultimate Strength kN	Maximum Allowable Load kN	Average Chain Weight kg/m
		Pitch P	Roller		Pin				Plate					
			Width W	Dia. R	Dia. D	Length		Height H	Thick. T					
ANSI	35	9.525	4.80	*5.08	3.58	12.00	12.90	6.00	6.90	8.90	1.25	10.80	2.48	0.34
	40	12.70	7.95	7.92	3.96	16.50	17.90	8.30	9.60	11.60	1.50	19.10	4.17	0.60
	50	15.875	9.53	10.16	5.08	20.40	22.00	10.20	11.80	14.50	2.00	31.90	7.22	0.98
	60	19.05	12.70	11.91	5.95	25.50	26.90	12.80	14.10	17.40	2.40	43.10	10.70	1.46
	80	25.40	15.88	15.88	7.93	32.80	35.10	16.40	18.70	23.40	3.20	78.50	19.10	2.52
BS	08B	12.70	7.75	8.51	4.45	16.70	18.20	8.40	9.80	11.80	1.50	17.80	3.14	0.61
	10B	15.875	9.65	10.16	5.08	19.00	20.70	9.50	11.20	14.70	1.65	22.20	4.90	0.89
	12B	19.05	11.68	12.07	5.72	22.00	23.60	11.00	12.60	16.10	1.80	28.90	7.06	1.14
	16B	25.40	17.02	15.88	8.26	35.10	38.20	17.60	20.60	21.00	3.20/4.00	60.00	16.40	2.59

*Bushing Dia.

This coating is available for other kinds of roller chains.

CONTENTS

ROLLER CHAINS

Standard Roller Chains	8
ANSI Standard Roller Chains	10
BS Standard Roller Chains	23
Heavy Series Roller Chains(H Series)	25
HE Series	26
Straight Sidebar Chains	27
Super Roller Chains	28
Double Capacity Chains	32
Freedom Series Self-Lubricating Chains	34
Lubeless Chains(O-ring Chain)	38
Heavy Duty Drive Chains	39

DOUBLE PITCH ROLLER CHAINS

Double Pitch Roller Chains(For Drive)	40
Double Pitch Roller Chains(For Conveyor)	41

HOLLOW PIN CHAINS

Hollow Pin Chains	42
Double Pitch Hollow Pin Chains	42
Stainless Hollow Pin Chains	43
Double Pitch Stainless Hollow Pin Chains	43

CORROSION RESISTANT ROLLER CHAINS

Stainless Steel Chains	44
Nickel-Plated Chains	46
Nickel-Plated Double Pitch Chains	47



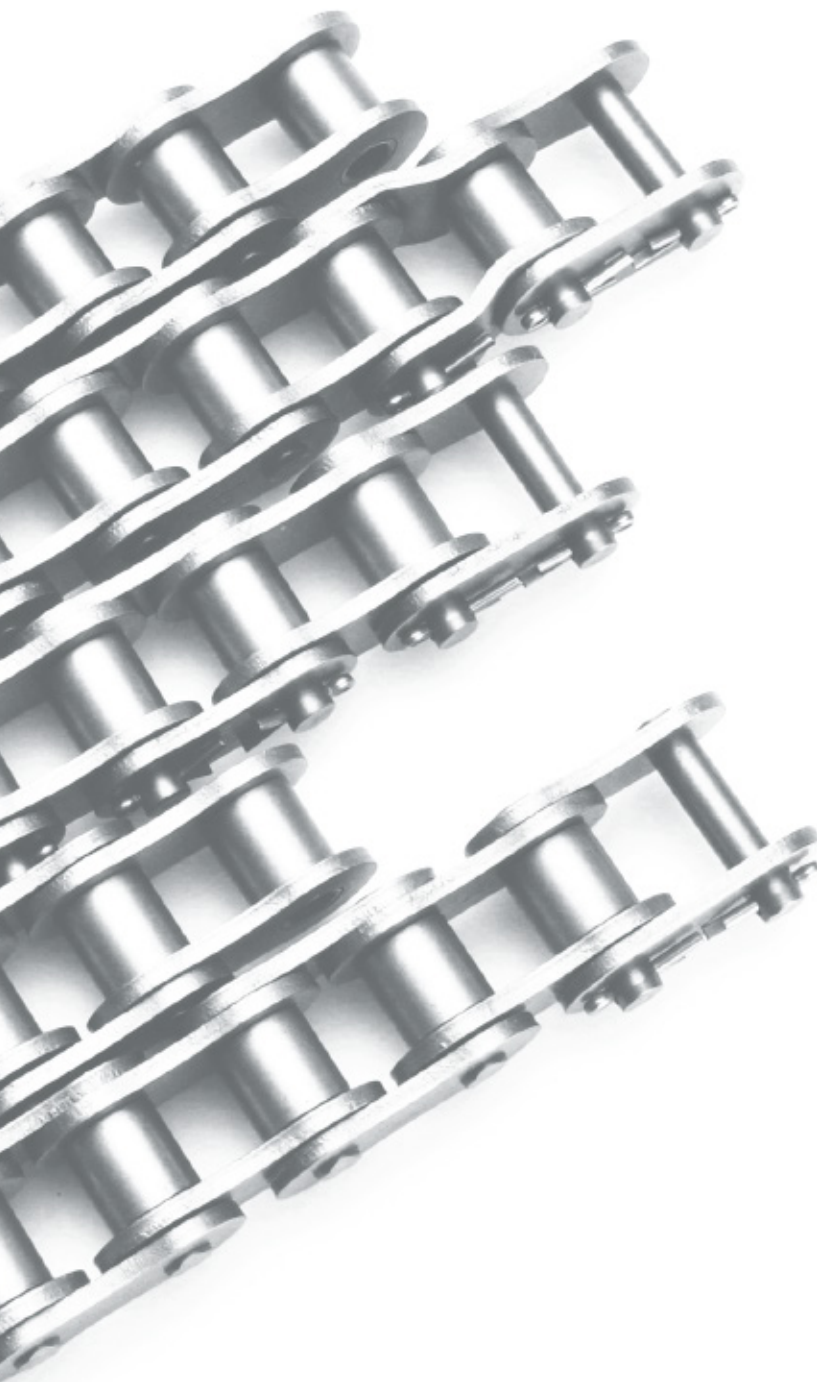

SIDE BOW CHAINS

Side Bow Chains	48
Side Bow Double Pitch Chains	48

LEAF CHAINS

Leaf Chains	49
-------------	----

ATTACHMENT CHAINS

ANSI Standard Attachment Chains	52
BS Standard Attachment Chains	54
Double Pitch Attachment Chains	56
Chains with Top Rollers	59
Side Roller Chains	60

TECHNICAL INFORMATION

Trouble Shooting Hints	61
Selection of Transmission Roller Chain	63
Installation and Arrangement	69
Lubrication	70
WARNING	71
CAUTION	72

Standard Roller Chains

HOW TO ORDER

Chain number, type: riveted or cottered, length and quantity are the necessary information for us to fill in your order. At the very least, the chain pitch, roller diameter and roller link inside width should be given if the chain number is unknown.

STANDARD PACKING

Roller chains are packed for convenient handling and storing. Each 10 feet length is packed in a carton, specifically as possible when ordering a cut length of chain.

NOMENCLATURE

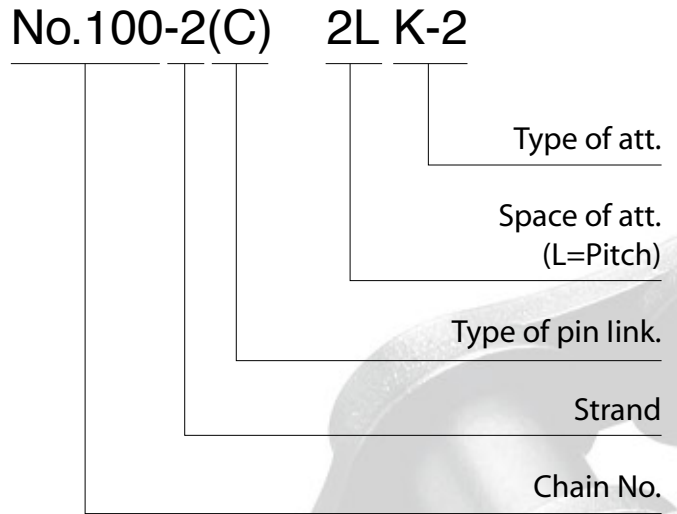

CHAIN PARTS



CHAIN CONNECTION PARTS

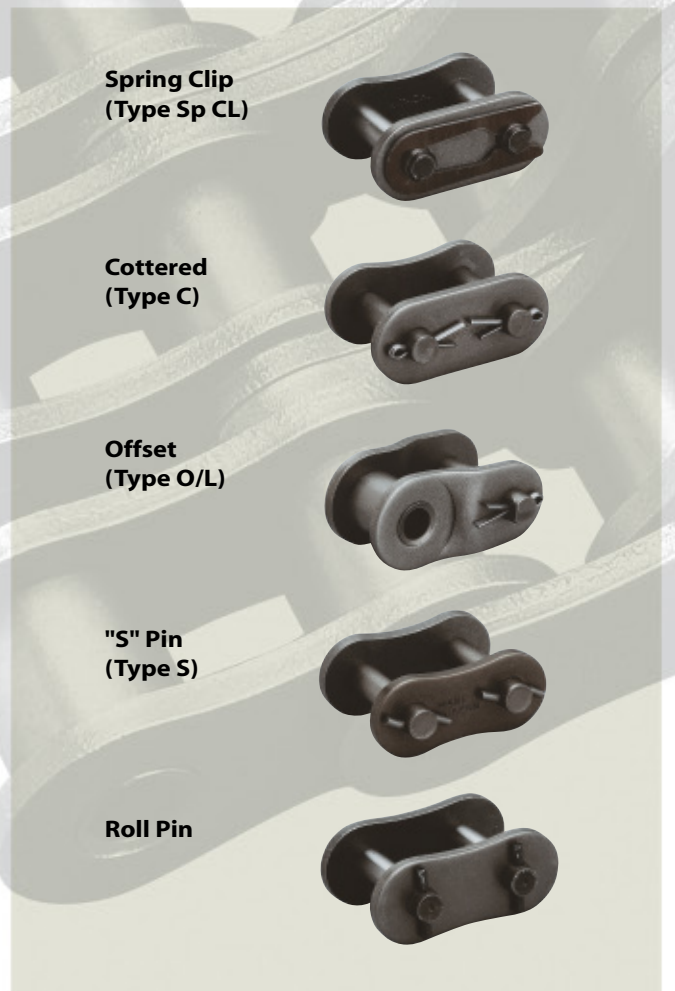

CHAIN CONSTRUCTION

RIVETED

Riveted chain is assembled by staking the pin heads on both sides of the chain.



SINGLE AND MULTIPLE

On multiple-strand types, all center plates are slip fitted (clearance-fitted) unless otherwise specified.

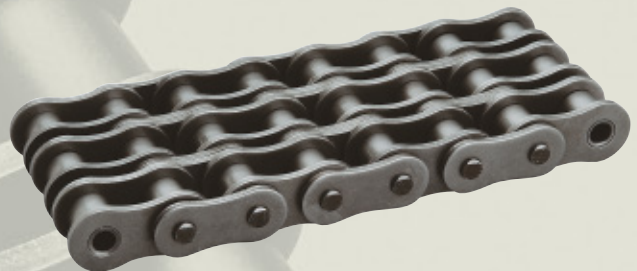

COTTERED

Cottered chain is assembled by staking the pin heads on one side of the chain and drilling a hole in the other end to accommodate a cotter pin. This type of chain is easily assembled and disassembled in the field.



Roller chain with connecting link (C/L)

Ordinarily even number of pitches includes a C/L on one end.



Roller chain with offset link (O/L)

When an odd number of pitches is required, a C/L and an O/L are usually used.



Roller chain with connecting links (C/L's) on both ends.

For odd pitches (not endless), 2C/L's are incorporated on request.



Note : If an endless chain assembly is required, specify whether it is to riveted endless or cotter-connected.

ANSI Standard Roller Chains

25 (BUSHED CHAIN)

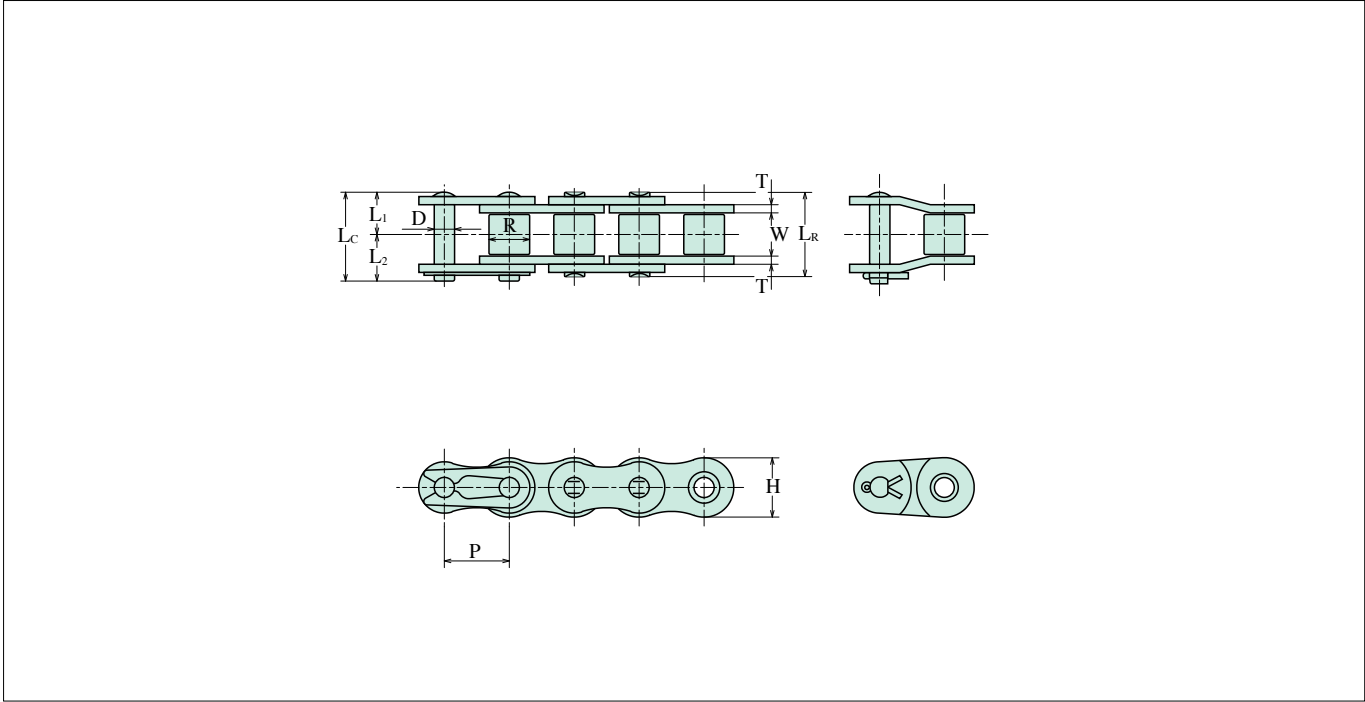

Chain No.	Dimensions - mm										Average Ultimate Strength	Maximum Allowable Load	Average Chain Weight
	Pitch	Bushing		Pin				Plate					
		Width	Dia.	Dia.	Length			Height	Thick.				
	P	W	R	D	L _R	L _C	L ₁	L ₂	H	T			
25	6.35	3.10	3.30	2.31	7.60	8.60	3.80	4.80	6.02	0.75	4.40	0.64	0.13

KILOWATT RATING OF 25

(kw)

No. of Teeth Small Spkt	Revolutions per Minute(RPM)-Small Sprocket																			
	100	500	900	1200	1800	2500	3000	3500	4000	4500	5000	5500	6000	6500	7000	7500	8000	8500	9000	10000
	Lubrication Method																			
	A					C														
9	0.03	0.13	0.23	0.30	0.43	0.57	0.67	0.78	0.76	0.64	0.54	0.47	0.42	0.37	0.33	0.30	0.27	0.25	0.22	0.19
10	0.04	0.15	0.26	0.33	0.48	0.64	0.76	0.87	0.89	0.75	0.64	0.55	0.48	0.43	0.39	0.35	0.31	0.29	0.26	0.22
11	0.04	0.17	0.28	0.37	0.53	0.71	0.84	0.96	1.03	0.87	0.74	0.64	0.56	0.50	0.45	0.40	0.37	0.34	0.31	0.26
12	0.04	0.18	0.31	0.40	0.58	0.78	0.92	1.06	1.17	0.98	0.84	0.72	0.64	0.57	0.51	0.46	0.42	0.38	0.35	0.30
13	0.05	0.20	0.34	0.44	0.63	0.85	1.00	1.15	1.30	1.11	0.95	0.82	0.72	0.64	0.57	0.51	0.47	0.43	0.40	0.34
14	0.05	0.22	0.37	0.48	0.69	0.92	1.09	1.25	1.41	1.24	1.06	0.92	0.81	0.72	0.64	0.57	0.52	0.48	0.44	0.37
15	0.05	0.23	0.40	0.51	0.74	0.99	1.17	1.35	1.52	1.37	1.17	1.01	0.90	0.79	0.71	0.64	0.58	0.53	0.48	0.42
16	0.06	0.25	0.43	0.55	0.79	1.07	1.26	1.44	1.63	1.51	1.29	1.12	0.98	0.87	0.78	0.70	0.64	0.58	0.54	0.46
17	0.06	0.27	0.45	0.59	0.85	1.14	1.34	1.54	1.74	1.66	1.42	1.22	1.07	0.96	0.85	0.77	0.70	0.64	0.59	0.50
18	0.07	0.28	0.48	0.63	0.90	1.21	1.43	1.64	1.85	1.81	1.54	1.34	1.17	1.04	0.93	0.84	0.76	0.69	0.64	0.54
19	0.07	0.30	0.51	0.66	0.96	1.28	1.51	1.74	1.96	1.95	1.67	1.45	1.27	1.13	1.01	0.91	0.83	0.75	0.69	0.59
20	0.07	0.32	0.54	0.70	1.01	1.36	1.60	1.84	2.07	2.11	1.81	1.57	1.37	1.22	1.09	0.98	0.90	0.81	0.75	0.64
21	0.08	0.34	0.57	0.74	1.06	1.43	1.69	1.94	2.18	2.27	1.94	1.69	1.48	1.31	1.17	1.06	0.96	0.87	0.81	0.69
22	0.08	0.35	0.60	0.78	1.12	1.50	1.77	2.04	2.30	2.44	2.08	1.81	1.58	1.40	1.26	1.13	1.03	0.94	0.87	0.74
23	0.09	0.37	0.63	0.82	1.17	1.58	1.86	2.14	2.41	2.61	2.22	1.93	1.69	1.50	1.34	1.21	1.10	1.01	0.93	0.79
24	0.09	0.39	0.66	0.85	1.23	1.65	1.95	2.24	2.52	2.78	2.37	2.06	1.81	1.60	1.43	1.29	1.17	1.07	0.98	0.84
25	0.10	0.41	0.69	0.89	1.28	1.73	2.03	2.34	2.64	2.93	2.52	2.19	1.92	1.70	1.52	1.37	1.25	1.14	1.04	0.90
26	0.10	0.42	0.72	0.93	1.34	1.80	2.12	2.44	2.75	3.06	2.68	2.32	2.04	1.81	1.61	1.45	1.32	1.21	1.11	0.95
28	0.11	0.46	0.78	1.01	1.45	1.95	2.30	2.64	2.98	3.31	2.99	2.59	2.28	2.01	1.81	1.63	1.48	1.35	1.24	1.06
30	0.12	0.49	0.84	1.09	1.56	2.10	2.48	2.85	3.21	3.57	3.32	2.87	2.52	2.24	2.00	1.81	1.64	1.50	1.37	1.17
32	0.12	0.53	0.90	1.16	1.68	2.25	2.66	3.05	3.44	3.83	3.66	3.17	2.78	2.46	2.21	1.99	1.81	1.65	1.51	1.29
35	0.14	0.58	0.99	1.28	1.85	2.48	2.93	3.36	3.79	4.21	4.18	3.62	3.18	2.82	2.52	2.28	2.07	1.89	1.73	1.48
40	0.16	0.67	1.14	1.48	2.13	2.87	3.38	3.88	4.38	4.87	5.10	4.42	3.89	3.45	3.08	2.78	2.52	2.31	2.11	1.81
45	0.18	0.77	1.30	1.68	2.42	3.26	3.84	4.41	4.97	5.53	6.08	5.28	4.63	4.11	3.68	3.32	3.01	2.75	2.52	2.16

Note: Lubricated types A,B,C and D on the table are shown on page 70.

: Whenever possible, selection should not be made from the colored sections of the table.

35 (BUSHED CHAIN)

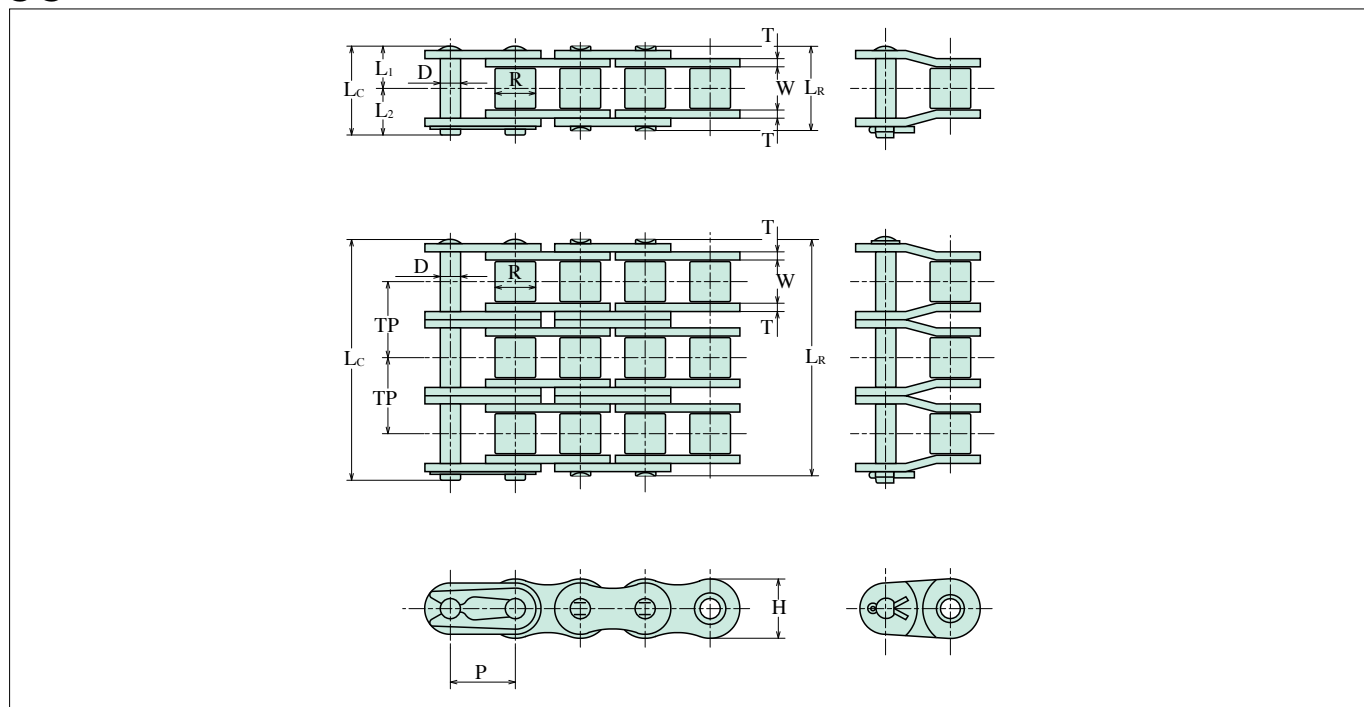

Chain No.	Dimensions - mm											Average Ultimate Strength kN	Maximum Allowable Load kN	Average Chain Weight kg/m	
	Pitch P	Bushing		Pin				Plate		Trans. Pitch TP					
		Width W	Dia. R	Dia. D	Length		Height H	Thick. T							
35						12.00	12.90	6.00	6.90			—	10.80	2.48	0.34
35-2	9.525	4.80	5.08	3.58		22.10	23.00	11.10	11.90	8.90	1.25	10.10	21.60	3.67	0.63
35-3						32.20	33.10	16.10	17.00				32.40	5.40	0.92

KILOWATT RATING OF 35

(kw)

No. of Teeth Small Spkt.	Revolutions per Minute(RPM)-Small Sprocket																			
	50	100	300	500	700	900	1200	1500	1800	2100	2500	3000	3500	4000	4500	5000	5500	6000	6500	7000
	Lubrication Method																			
	A			B			C			D										
11	0.10	0.20	0.52	0.83	1.12	1.41	1.83	2.23	2.63	3.02	2.88	2.19	1.74	1.42	1.19	1.02	0.88	0.77	0.69	0.61
12	0.11	0.21	0.58	0.91	1.24	1.55	2.01	2.45	2.89	3.32	3.28	2.50	1.98	1.62	1.36	1.16	1.01	0.88	0.78	0.70
13	0.13	0.23	0.63	0.99	1.35	1.69	2.19	2.67	3.15	3.62	3.70	2.82	2.23	1.83	1.53	1.31	1.13	1.00	0.88	0.79
14	0.14	0.25	0.68	1.08	1.46	1.83	2.37	2.90	3.41	3.92	4.14	3.15	2.50	2.04	1.71	1.46	1.27	1.11	0.99	0.88
15	0.15	0.27	0.73	1.16	1.57	1.97	2.55	3.12	3.68	4.23	4.59	3.49	2.77	2.27	1.90	1.62	1.41	1.23	1.09	0.98
16	0.16	0.29	0.79	1.25	1.69	2.11	2.74	3.35	3.94	4.53	5.05	3.84	3.05	2.50	2.09	1.79	1.55	1.36	1.21	1.08
17	0.17	0.31	0.84	1.33	1.80	2.26	2.92	3.57	4.21	4.84	5.54	4.21	3.34	2.73	2.29	1.96	1.70	1.49	1.32	1.18
18	0.18	0.33	0.89	1.41	1.91	2.40	3.11	3.80	4.48	5.14	6.02	4.59	3.64	2.98	2.50	2.13	1.85	1.62	1.44	1.29
19	0.19	0.35	0.95	1.50	2.03	2.54	3.30	4.03	4.75	5.45	6.38	4.98	3.95	3.23	2.71	2.31	2.00	1.76	1.56	1.40
20	0.20	0.37	1.00	1.58	2.14	2.69	3.48	4.26	5.02	5.76	6.74	5.37	4.26	3.49	2.92	2.50	2.16	1.90	1.68	1.51
21	0.21	0.39	1.05	1.67	2.26	2.83	3.67	4.49	5.29	6.08	7.11	5.78	4.59	3.75	3.15	2.69	2.33	2.04	1.81	1.62
22	0.22	0.41	1.11	1.76	2.38	2.98	3.86	4.72	5.56	6.39	7.48	6.20	4.92	4.03	3.37	2.88	2.50	2.19	1.94	1.74
23	0.23	0.43	1.16	1.84	2.49	3.13	4.05	4.95	5.84	6.70	7.84	6.63	5.26	4.30	3.61	3.08	2.67	2.34	2.08	1.86
24	0.24	0.45	1.22	1.93	2.61	3.27	4.24	5.19	6.11	7.02	8.21	7.06	5.61	4.59	3.84	3.28	2.85	2.50	2.21	1.98
25	0.25	0.47	1.27	2.02	2.73	3.42	4.43	5.42	6.39	7.34	8.58	7.51	5.96	4.88	4.09	3.49	3.03	2.65	2.35	2.11
26	0.26	0.49	1.33	2.10	2.85	3.57	4.63	5.65	6.66	7.65	8.95	7.96	6.32	5.17	4.34	3.70	3.21	2.82	2.50	2.23
28	0.29	0.54	1.44	2.28	3.08	3.87	5.01	6.12	7.22	8.29	9.70	8.90	7.06	5.78	4.84	4.14	3.59	3.15	2.79	2.50
30	0.31	0.58	1.55	2.45	3.32	4.17	5.40	6.60	7.78	8.93	10.45	9.87	7.83	6.41	5.37	4.59	3.98	3.49	3.10	2.77
32	0.33	0.62	1.66	2.63	3.56	4.47	5.79	7.07	8.34	9.58	11.20	10.87	8.63	7.06	5.92	5.05	4.38	3.84	3.41	3.05
35	0.37	0.68	1.83	2.90	3.93	4.92	6.38	7.79	9.18	10.55	12.34	12.44	9.87	8.08	6.77	5.78	5.01	4.40	3.90	3.49
40	0.42	0.79	2.12	3.35	4.53	5.68	7.36	9.00	10.61	12.19	14.26	15.20	12.06	9.87	8.27	7.06	6.12	5.37	4.77	4.26
45	0.48	0.89	2.40	3.80	5.15	6.46	8.36	10.22	12.05	13.84	16.19	18.13	14.39	11.78	9.87	8.43	7.31	6.41	5.69	5.09

Note: Lubricated types A,B,C and D on the table are shown on page 70.

: Whenever possible, selection should not be made from the colored sections of the table.

40

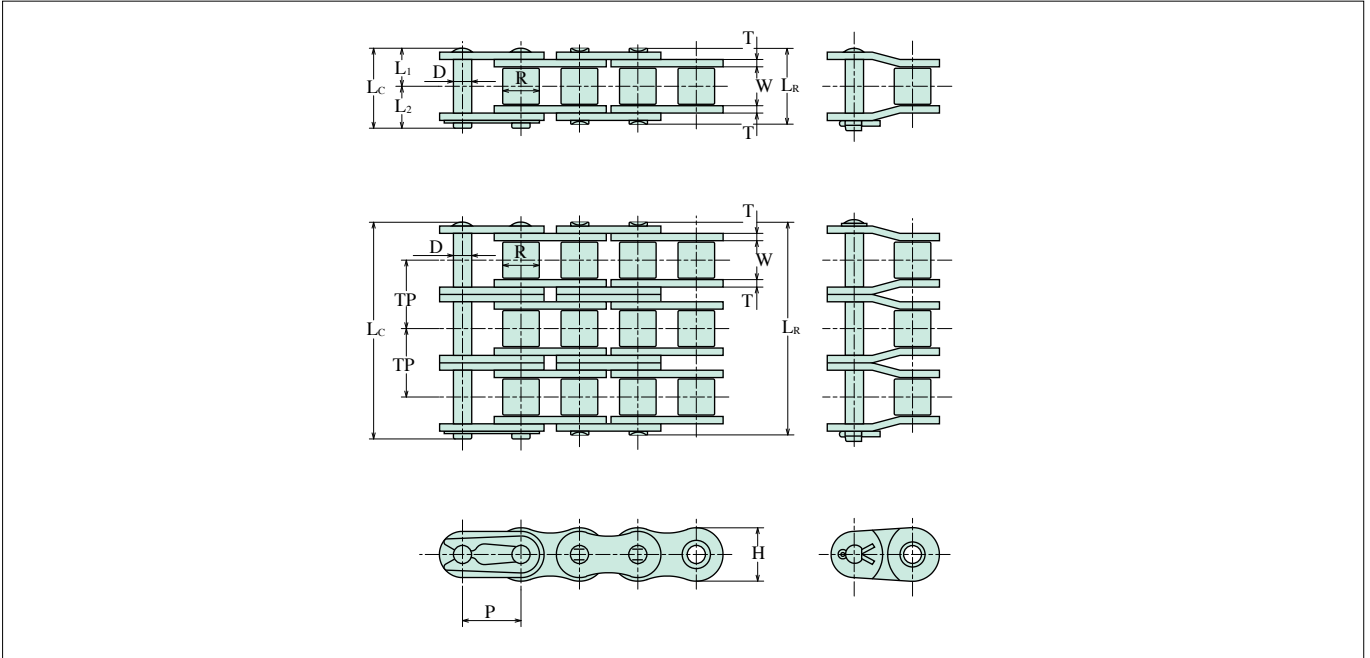

Chain No.	Dimensions - mm											Average Ultimate Strength kN	Maximum Allowable Load kN	Average Chain Weight kg/m
	Pitch P	Roller		Pin				Plate		Trans. Pitch TP				
		Width W	Dia. R	Dia. D	Length		Height H	Thick. T						
					LR	LC	L1	L2						
40					16.50	17.90	8.30	9.60			—	19.10	4.17	0.60
40-2	12.70	7.95	7.92	3.96	30.80	32.20	15.40	16.80	11.60	1.50	14.40	38.20	6.17	1.22
40-3					45.00	46.60	22.50	24.10				57.30	9.08	1.85
40-4					60.00	60.80	30.00	30.80				76.40	12.00	2.46

KILOWATT RATING OF 40

(kw)

No. of Teeth Small Splt.	Revolutions per Minute(RPM)-Small Sprocket																			
	10	25	50	100	200	300	400	500	700	900	1000	1200	1400	1600	1800	2100	2400	2700	3000	3500
	Lubrication Method																			
	A				B				C											
11	0.06	0.13	0.25	0.46	0.86	1.24	1.61	1.97	2.66	3.34	3.67	4.32	4.97	4.15	3.48	2.76	2.26	1.89	1.62	1.28
12	0.06	0.15	0.27	0.51	0.95	1.36	1.77	2.16	2.92	3.67	4.03	4.75	5.46	4.73	3.96	3.15	2.58	2.16	1.84	1.46
13	0.07	0.16	0.30	0.55	1.03	1.49	1.93	2.35	3.19	4.00	4.39	5.18	5.95	5.33	4.47	3.55	2.90	2.43	2.08	1.65
14	0.08	0.17	0.32	0.60	1.12	1.61	2.09	2.55	3.45	4.33	4.76	5.61	6.44	5.96	5.00	3.96	3.25	2.72	2.32	1.84
15	0.08	0.19	0.35	0.65	1.20	1.74	2.25	2.75	3.72	4.66	5.13	6.04	6.94	6.61	5.54	4.40	3.60	3.02	2.58	2.04
16	0.09	0.20	0.37	0.69	1.29	1.86	2.41	2.95	3.99	5.00	5.50	6.48	7.44	7.28	6.10	4.84	3.96	3.32	2.84	2.25
17	0.09	0.21	0.40	0.74	1.38	1.99	2.57	3.15	4.26	5.34	5.87	6.92	7.95	7.98	6.69	5.31	4.34	3.64	3.11	2.47
18	0.10	0.23	0.42	0.79	1.47	2.11	2.74	3.35	4.53	5.68	6.25	7.36	8.45	8.69	7.28	5.78	4.73	3.96	3.39	2.69
19	0.10	0.24	0.45	0.83	1.56	2.24	2.90	3.55	4.80	6.02	6.62	7.80	8.96	9.43	7.90	6.27	5.13	4.30	3.67	2.91
20	0.11	0.25	0.47	0.88	1.64	2.37	3.07	3.75	5.08	6.36	7.00	8.25	9.47	10.18	8.53	6.77	5.54	4.64	3.96	3.15
21	0.12	0.27	0.50	0.93	1.73	2.50	3.23	3.95	5.35	6.71	7.38	8.69	9.99	10.95	9.18	7.28	5.96	5.00	4.27	3.39
22	0.12	0.28	0.52	0.98	1.82	2.62	3.40	4.16	5.63	7.05	7.76	9.14	10.50	11.74	9.84	7.81	6.39	5.36	4.57	3.63
23	0.13	0.29	0.55	1.02	1.91	2.75	3.57	4.36	5.90	7.40	8.14	9.59	11.02	12.42	10.52	8.35	6.83	5.73	4.89	3.88
24	0.14	0.31	0.57	1.07	2.00	2.88	3.74	4.57	6.18	7.75	8.52	10.04	11.53	13.01	11.21	8.90	7.28	6.10	5.21	4.14
25	0.14	0.32	0.60	1.12	2.09	3.01	3.90	4.77	6.46	8.10	8.90	10.49	12.05	13.59	11.92	9.46	7.74	6.49	5.54	4.40
26	0.15	0.34	0.63	1.17	2.18	3.14	4.07	4.98	6.74	8.45	9.29	10.95	12.58	14.18	12.64	10.03	8.21	6.88	5.88	4.66
28	0.16	0.36	0.68	1.27	2.36	3.41	4.41	5.39	7.30	9.15	10.06	11.86	13.62	15.36	14.13	11.21	9.18	7.69	6.57	5.21
30	0.17	0.39	0.73	1.37	2.55	3.67	4.75	5.81	7.87	9.86	10.80	12.78	14.68	16.55	15.67	12.44	10.18	8.53	7.28	5.78
32	0.18	0.42	0.78	1.46	2.73	3.93	5.10	6.23	8.43	10.60	11.60	13.70	15.74	17.75	17.27	13.70	11.21	9.40	8.02	6.37
35	0.20	0.46	0.86	1.61	3.01	4.33	5.61	6.86	9.29	11.60	12.80	15.09	17.34	19.55	19.75	15.67	12.83	10.75	9.18	7.28
40	0.23	0.53	1.00	1.86	3.48	5.01	6.49	7.93	10.70	13.50	14.80	17.43	20.03	22.58	24.13	19.15	15.67	13.13	11.21	8.90
45	0.27	0.61	1.13	2.12	3.95	5.69	7.37	9.00	12.20	15.30	16.80	19.80	22.74	25.65	28.51	22.85	18.70	15.67	13.38	10.62
	A			B		C					D									

Note: Lubricated types A,B,C and D on the table are shown on page 70.

: Whenever possible, selection should not be made from the colored sections of the table.

50

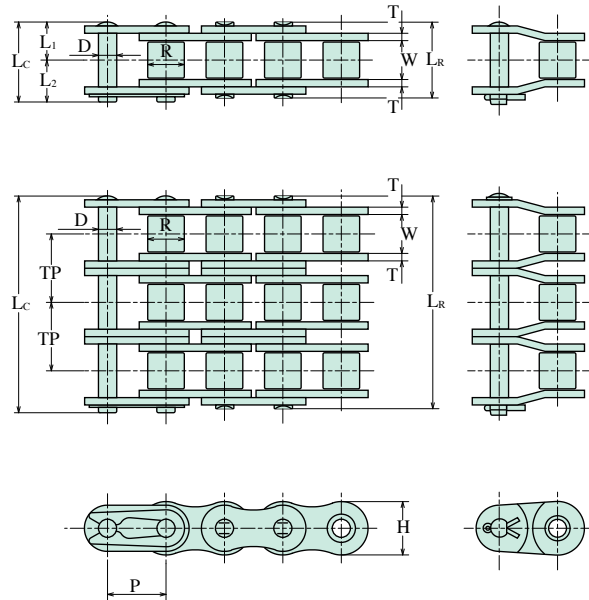

Chain No.	Dimensions - mm											Average Ultimate Strength kN	Maximum Allowable Load kN	Average Chain Weight kg/m	
	Pitch P	Roller		Pin				Plate		Trans. Pitch TP					
		Width W	Dia. R	Dia. D	Length			Height H	Thick. T						
					L _R	L _C	L ₁	L ₂							
50						20.40	22.00	10.20	11.80			—	31.90	7.22	0.98
50-2	15.875	9.53	10.16	5.08	38.40	40.00	19.20	20.80		14.50	2.00	18.10	63.80	10.70	2.00
50-3					56.70	58.20	28.40	29.80					95.70	15.70	3.07
50-4					75.00	75.70	37.50	38.20					128.00	20.70	3.97

KILOWATT RATING OF 50

(kw)

No. of Teeth Small Spkt.	Revolutions per Minute(RPM)-Small Sprocket																			
	10	25	50	100	200	300	400	500	700	900	1000	1200	1400	1600	1800	2100	2400	2700	3000	3500
	Lubrication Method																			
	A				B				C				D							
11	0.11	0.26	0.48	0.90	1.68	2.42	3.13	3.83	5.18	6.49	7.14	7.64	6.06	4.96	4.16	3.30	2.70	2.26	1.93	1.53
12	0.12	0.28	0.53	0.99	1.84	2.65	3.44	4.20	5.69	7.13	7.84	8.71	6.91	5.66	4.74	3.76	3.08	2.58	2.20	1.75
13	0.14	0.31	0.58	1.08	2.01	2.89	3.75	4.58	6.20	7.78	8.55	9.82	7.79	6.38	5.34	4.24	3.47	2.91	2.48	1.97
14	0.15	0.33	0.62	1.17	2.18	3.13	4.06	4.96	6.72	8.43	9.26	10.90	8.71	7.13	5.97	4.74	3.88	3.25	2.78	2.20
15	0.16	0.36	0.67	1.26	2.34	3.38	4.38	5.35	7.24	9.08	9.98	11.80	9.66	7.90	6.62	5.26	4.30	3.61	3.08	2.44
16	0.17	0.39	0.72	1.35	2.51	3.62	4.69	5.73	7.76	9.73	10.70	12.60	10.60	8.71	7.30	5.79	4.74	3.97	3.39	2.69
17	0.18	0.41	0.77	1.44	2.68	3.87	5.01	6.12	8.29	10.40	11.40	13.50	11.70	9.54	7.99	6.34	5.19	4.35	3.71	2.95
18	0.19	0.44	0.82	1.53	2.85	4.11	5.33	6.51	8.82	11.10	12.20	14.30	12.70	10.40	8.71	6.91	5.66	4.74	4.05	3.21
19	0.20	0.47	0.87	1.62	3.03	4.36	5.65	6.90	9.35	11.70	12.90	15.20	13.80	11.30	9.44	7.49	6.13	5.14	4.39	3.48
20	0.22	0.49	0.92	1.71	3.20	4.61	5.97	7.30	9.88	12.40	13.60	16.00	14.90	12.20	10.20	8.09	6.62	5.55	4.74	3.76
21	0.23	0.52	0.97	1.81	3.37	4.86	6.29	7.69	10.40	13.10	14.40	16.90	16.00	13.10	11.00	8.71	7.13	5.97	5.10	4.05
22	0.24	0.55	1.02	1.90	3.55	5.11	6.62	8.09	10.90	13.70	15.10	17.80	17.20	14.00	11.80	9.34	7.64	6.40	5.47	4.34
23	0.25	0.57	1.07	1.99	3.72	5.36	6.94	8.49	11.50	14.40	15.80	18.70	18.30	15.00	12.60	9.98	8.17	6.85	5.85	4.64
24	0.26	0.60	1.12	2.09	3.90	5.61	7.27	8.89	12.00	15.10	16.60	19.50	19.50	16.00	13.40	10.60	8.71	7.30	6.23	4.94
25	0.27	0.63	1.17	2.18	4.07	5.86	7.60	9.29	12.60	15.80	17.30	20.40	20.80	17.00	14.30	11.30	9.26	7.76	6.62	5.26
26	0.29	0.65	1.22	2.28	4.25	6.12	7.93	9.69	13.10	16.40	18.10	21.30	22.00	18.00	15.10	12.00	9.82	8.23	7.03	5.58
28	0.31	0.71	1.32	2.47	4.60	6.63	8.59	10.50	14.20	17.80	19.60	23.10	24.60	20.20	16.90	13.40	11.00	9.20	7.85	6.23
30	0.33	0.76	1.42	2.66	4.96	7.14	9.25	11.30	15.30	19.20	21.10	24.90	27.30	22.40	18.70	14.90	12.20	10.20	8.71	6.91
32	0.36	0.82	1.53	2.85	5.31	7.66	9.92	12.10	16.40	20.60	22.60	26.70	30.10	24.60	20.60	16.40	13.40	11.20	9.59	7.61
35	0.39	0.90	1.68	3.14	5.85	8.43	10.90	13.40	18.10	22.70	24.90	29.40	33.70	28.20	23.60	18.70	15.30	12.90	11.00	8.71
40	0.46	1.04	1.94	3.62	6.76	9.74	12.60	15.40	20.90	26.20	28.80	33.90	39.00	34.40	28.80	22.90	18.70	15.70	13.40	10.60
45	0.52	1.18	2.21	4.12	7.68	11.10	14.30	17.50	23.70	29.70	32.70	38.50	44.30	41.10	34.40	27.30	22.40	18.70	16.00	12.70

Note: Lubricated types A,B,C and D on the table are shown on page 70.
: Whenever possible, selection should not be made from the colored sections of the table.

60

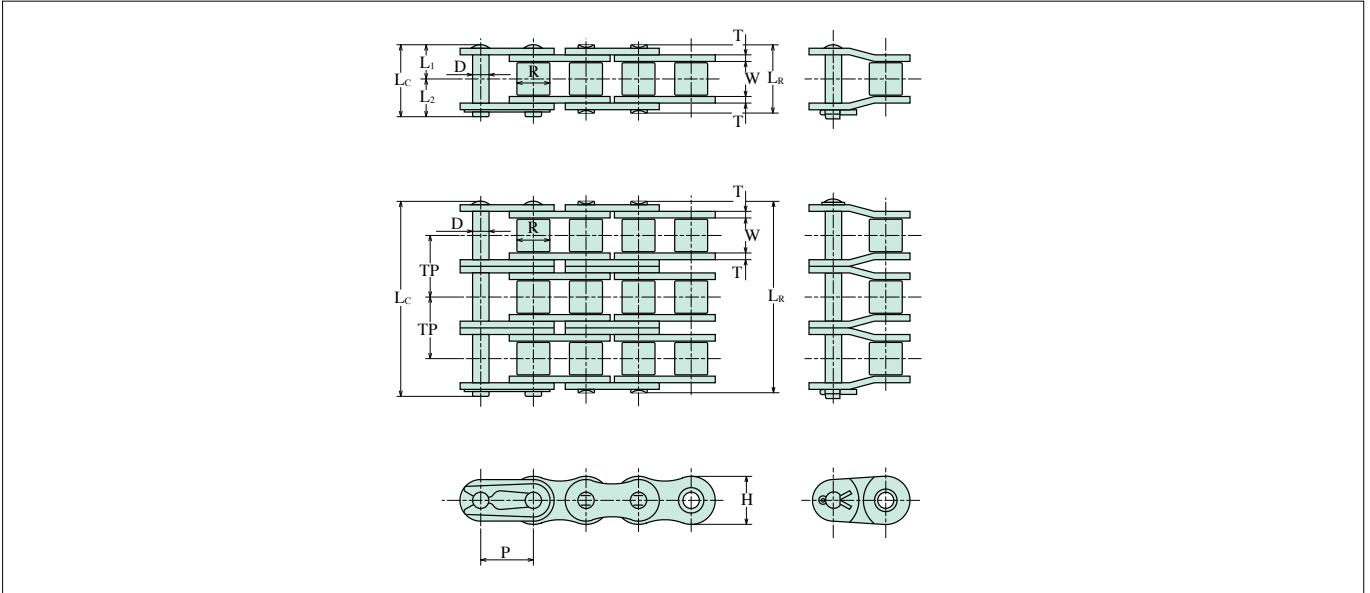

Chain No.	Dimensions - mm											Average Ultimate Strength	Maximum Allowable Load	Average Chain Weight
	Pitch	Roller		Pin				Plate		Trans. Pitch				
		Width	Dia.	Dia.	Length			Height	Thick.					
		P	W	R	D	LR	LC	L1	L2		H			
60					25.50	26.90	12.80	14.10			—	43.10	10.70	1.46
60-2					48.20	49.70	24.00	25.70				86.20	14.70	2.95
60-3					71.20	72.60	35.20	37.40				129.00	21.60	4.43
60-4	19.05	12.70	11.91	5.95	94.40	95.40	47.20	48.20	17.40	2.40	22.80	172.00	28.50	5.92
60-5					117.00	118.20	58.50	59.70				216.00	33.70	7.41
60-6					140.00	140.90	70.10	70.80				259.00	39.70	8.90

KILOWATT RATING OF 60

(kw)

No. of Teeth Small Spkt.	Revolutions per Minute(RPM)-Small Sprocket																				
	10	25	50	100	150	200	300	400	500	600	700	800	900	1000	1100	1200	1400	1600	1800	2000	
	Lubrication Method																				
	A					B					C					D					
11	0.21	0.48	0.90	1.68	2.42	3.13	4.51	5.85	7.15	8.42	9.68	10.90	12.10	13.20	11.60	10.10	8.84	7.02	5.74	4.81	4.11
12	0.23	0.53	0.99	1.84	2.66	3.44	4.96	6.42	7.85	9.25	10.60	12.00	13.30	13.20	11.50	10.10	7.99	6.54	5.48	4.68	
13	0.25	0.58	1.08	2.01	2.90	3.75	5.41	7.00	8.56	10.10	11.60	13.10	14.50	14.90	12.90	11.40	9.01	7.38	6.18	5.28	
14	0.27	0.63	1.17	2.18	3.14	4.07	5.86	7.59	9.27	10.90	12.60	14.20	15.70	16.70	14.50	12.70	10.10	8.25	6.91	5.90	
15	0.30	0.67	1.26	2.35	3.38	4.38	6.31	8.17	9.99	11.80	13.50	15.30	17.00	18.50	16.00	14.10	11.20	9.15	7.66	6.54	
16	0.32	0.72	1.35	2.52	3.62	4.70	6.76	8.76	10.70	12.60	14.50	16.40	18.20	20.00	17.70	15.50	12.30	10.10	8.44	7.21	
17	0.34	0.77	1.44	2.69	3.87	5.01	7.22	9.36	11.40	13.50	15.50	17.50	19.40	21.30	19.40	17.00	13.50	11.00	9.25	7.90	
18	0.36	0.82	1.53	2.86	4.12	5.33	7.68	9.95	12.20	14.30	16.50	18.60	20.60	22.70	21.10	18.50	14.70	12.00	10.10	8.60	
19	0.38	0.87	1.62	3.03	4.36	5.65	8.14	10.60	12.90	15.20	17.50	19.70	21.90	24.10	22.90	20.10	15.90	13.00	10.90	9.33	
20	0.40	0.92	1.72	3.20	4.61	5.98	8.61	11.20	13.60	16.10	18.50	20.80	23.10	25.40	24.70	21.70	17.20	14.10	11.80	10.10	
21	0.42	0.97	1.81	3.38	4.86	6.30	9.07	11.80	14.40	16.90	19.50	21.90	24.40	26.80	26.60	23.30	18.50	15.10	12.70	10.80	
22	0.45	1.02	1.90	3.55	5.11	6.62	9.54	12.40	15.10	17.80	20.50	23.10	25.60	28.20	28.50	25.00	19.80	16.20	13.60	11.60	
23	0.47	1.07	2.00	3.72	5.36	6.95	10.00	13.00	15.90	18.70	21.50	24.20	26.90	29.60	30.50	26.70	21.20	17.40	14.60	12.40	
24	0.49	1.12	2.09	3.90	5.62	7.28	10.50	13.60	16.60	19.60	22.50	25.30	28.20	31.00	32.50	28.50	22.60	18.50	15.50	13.20	
25	0.51	1.17	2.18	4.08	5.87	7.60	11.00	14.20	17.30	20.40	23.50	26.50	29.40	32.40	34.50	30.30	24.00	19.70	16.50	14.10	
26	0.54	1.22	2.28	4.25	6.12	7.93	11.40	14.80	18.10	21.30	24.50	27.60	30.70	33.80	36.60	32.10	25.50	20.90	17.50	14.90	
28	0.58	1.32	2.47	4.61	6.63	8.59	12.40	16.00	19.60	23.10	26.50	29.90	33.30	36.60	39.90	35.90	28.50	23.30	19.50	16.70	
30	0.62	1.42	2.66	4.96	7.15	9.26	13.30	17.30	21.10	24.90	28.60	32.20	35.80	39.40	42.90	39.80	31.60	25.90	21.70	18.50	
32	0.67	1.53	2.85	5.32	7.66	9.93	14.30	18.50	22.60	26.70	30.70	34.60	38.40	42.30	46.00	43.90	34.80	28.50	23.90	20.40	
35	0.74	1.68	3.14	5.86	8.44	10.90	15.80	20.40	24.90	29.40	33.80	38.10	42.30	46.60	50.70	50.20	39.80	32.60	27.30	23.30	
40	0.85	1.94	3.63	6.77	9.75	12.60	18.20	23.60	28.80	34.00	39.00	44.00	48.90	53.80	58.60	61.30	48.70	39.80	33.40	28.50	
45	0.97	2.21	4.12	7.69	11.07	14.30	20.70	26.80	32.70	38.60	44.30	50.00	55.50	61.10	66.50	72.00	58.10	47.50	39.80	34.00	

Note: Lubricated types A,B,C and D on the table are shown on page 70.

: Whenever possible, selection should not be made from the colored sections of the table.

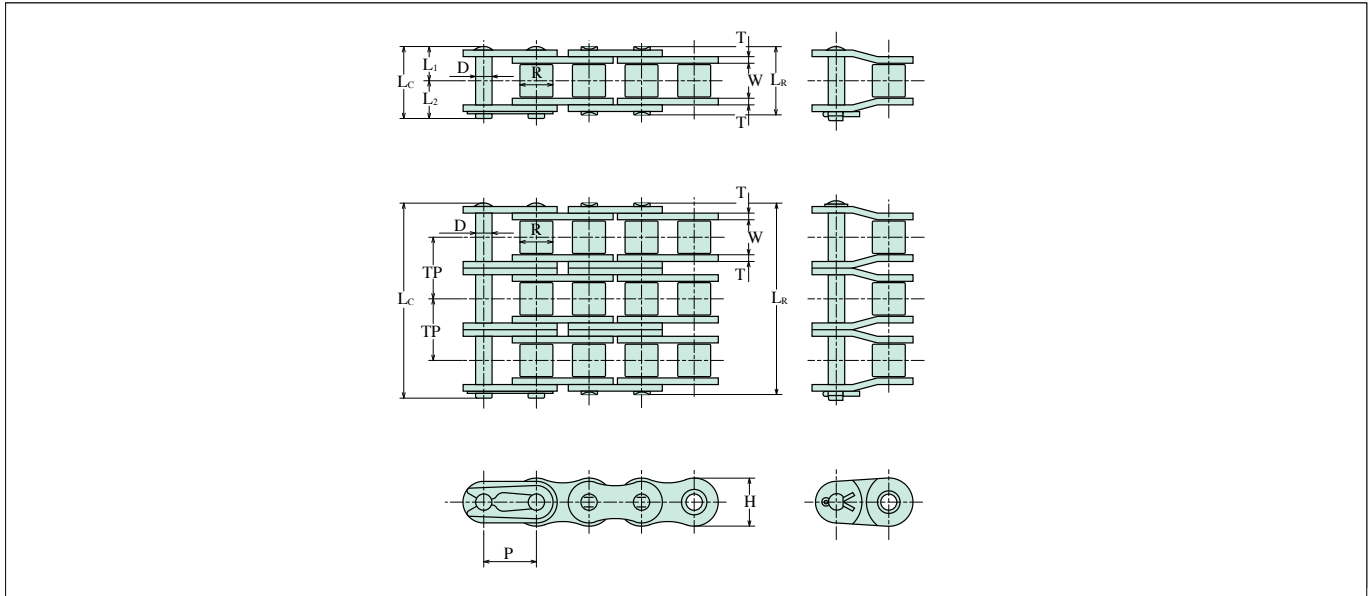

Chain No.	Dimensions - mm											Average Ultimate Strength kN	Maximum Allowable Load kN	Average Chain Weight kg/m
	Pitch P	Roller		Pin				Plate		Trans. Pitch TP				
		Width W	Dia. R	Dia. D	Length		Height H	Thick. T						
					LR	LC	L1	L2						
80					32.80	35.10	16.40	18.70			—	78.50	19.10	2.52
80-2					61.60	64.50	30.80	33.70				157.00	25.00	5.10
80-3	25.40	15.88	15.88	7.93	90.90	94.10	45.50	48.60	23.40	3.20	29.30	236.00	36.80	7.68
80-4					120.40	123.50	60.20	63.30				314.00	48.50	10.25
80-5					149.80	152.80	74.90	77.90				393.00	57.30	12.84
80-6					179.10	182.10	89.60	92.50				471.00	67.60	15.42

KILOWATT RATING OF 80

(kw)

No. of Teeth Small Spkt.	Revolutions per Minute(RPM)-Small Sprocket																			
	10	25	50	100	150	200	300	400	500	600	700	800	900	1000	1100	1200	1400	1600	1800	2000
	A					B					C					D				
11	0.66	1.51	2.82	5.27	7.59	9.83	14.20	18.30	22.40	26.40	25.00	20.40	17.10	14.60	12.70	11.10	8.83	7.23	6.06	5.17
12	0.73	1.66	3.10	5.79	8.34	10.80	15.60	20.20	24.60	29.00	28.50	23.30	19.50	16.70	14.50	12.70	10.10	8.24	6.90	5.89
13	0.79	1.81	3.38	6.31	9.09	11.80	17.00	22.00	26.90	31.70	32.10	26.30	22.00	18.80	16.30	14.30	11.30	9.29	7.78	6.65
14	0.86	1.96	3.66	6.84	9.85	12.80	18.40	23.80	29.10	34.30	35.90	29.40	24.60	21.00	18.20	16.00	12.70	10.40	8.70	7.43
15	0.93	2.12	3.95	7.37	10.60	13.70	19.80	25.60	31.40	36.90	39.80	32.60	27.30	23.30	20.20	17.70	14.10	11.50	9.65	8.24
16	0.99	2.27	4.23	7.90	11.40	14.70	21.20	27.50	33.60	39.60	43.80	35.90	30.10	25.70	22.20	19.50	15.50	12.70	10.60	9.07
17	1.06	2.42	4.52	8.43	12.10	15.70	22.70	29.40	35.90	42.30	48.00	39.30	32.90	28.10	24.40	21.40	17.00	13.90	11.60	9.94
18	1.13	2.58	4.81	8.97	12.90	16.70	24.10	31.20	38.20	45.00	51.70	42.80	35.90	30.60	26.50	23.30	18.50	15.10	12.70	10.80
19	1.20	2.73	5.10	9.51	13.70	17.70	25.60	33.10	40.50	47.70	54.80	46.40	38.90	33.20	28.80	25.30	20.10	16.40	13.80	11.70
20	1.27	2.89	5.39	10.00	14.50	18.80	27.00	35.00	42.80	50.40	57.90	50.10	42.00	35.90	31.10	27.30	21.70	17.70	14.90	12.70
21	1.33	3.04	5.68	10.60	15.30	19.80	28.50	36.90	45.10	53.10	61.00	53.90	45.20	38.60	33.50	29.40	23.30	19.10	16.00	13.60
22	1.40	3.20	5.97	11.10	16.00	20.80	29.90	38.80	47.40	55.90	64.20	57.80	48.50	41.40	35.90	31.50	25.00	20.40	17.10	14.60
23	1.47	3.36	6.26	11.70	16.80	21.80	31.40	40.70	49.70	58.60	67.30	61.80	51.80	44.20	38.30	33.70	26.70	21.90	18.30	15.60
24	1.54	3.51	6.56	12.20	17.60	22.80	32.90	42.60	52.10	61.40	70.50	65.90	55.20	47.20	40.90	35.90	28.50	23.30	19.50	16.70
25	1.61	3.67	6.85	12.80	18.40	23.90	34.40	44.50	54.40	64.10	73.70	70.10	58.70	50.10	43.50	38.10	30.30	24.80	20.80	17.70
26	1.68	3.83	7.15	13.30	19.20	24.90	35.90	46.50	56.80	66.90	76.90	74.30	62.30	53.20	46.10	40.40	32.10	26.30	22.00	18.80
28	1.82	4.15	7.75	14.50	20.80	27.00	38.80	50.30	61.50	72.50	83.30	83.00	69.60	59.40	51.50	45.20	35.90	29.40	24.60	21.00
30	1.96	4.47	8.34	15.60	22.40	29.10	41.90	54.20	66.30	78.10	89.70	92.10	77.20	65.90	57.10	50.10	39.80	32.60	27.30	23.30
32	2.10	4.79	8.95	16.70	24.00	31.20	44.90	58.10	71.10	83.70	96.20	101.00	85.00	72.60	62.90	55.20	43.80	35.90	30.10	25.70
35	2.32	5.28	9.86	18.40	26.50	34.30	49.40	64.00	78.30	92.20	106.00	116.00	97.30	83.00	72.00	63.20	50.10	41.00	34.40	29.40
40	2.67	6.10	11.40	21.20	30.60	39.60	57.10	74.00	90.40	107.00	122.00	138.00	119.00	101.00	87.90	77.20	61.20	50.10	42.00	35.90
45	3.04	6.93	12.90	24.10	34.80	45.00	64.80	84.00	103.00	121.00	139.00	157.00	142.00	121.00	105.00	92.10	73.10	59.80	50.10	42.80

Note: Lubricated types A,B,C and D on the table are shown on page 70.

: Whenever possible, selection should not be made from the colored sections of the table.

100

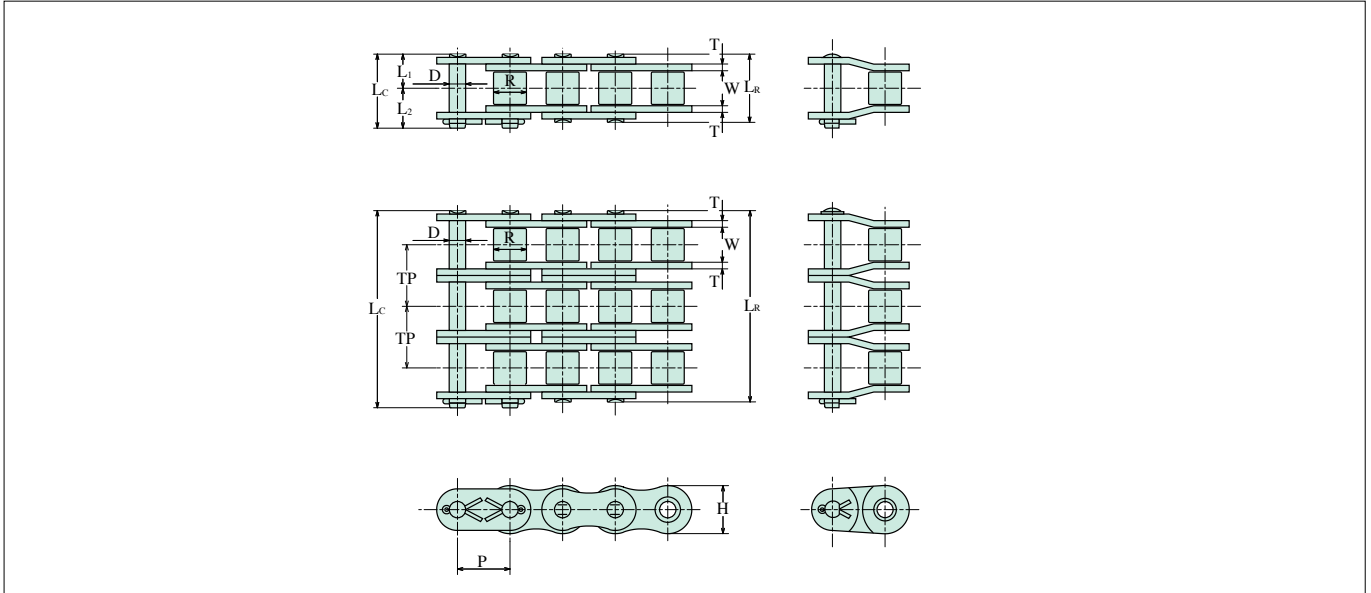

Chain No.	Dimensions - mm											Average Ultimate Strength kN	Maximum Allowable Load kN	Average Chain Weight kg/m
	Pitch P	Roller		Pin				Plate		Trans. Pitch TP				
		Width W	Dia. R	Dia. D	Length			Height H	Thick. T					
					LR	LC	L1	L2						
100					39.40	43.00	19.70	23.30			—	118.00	29.40	3.84
100-2					75.10	78.80	37.60	41.20				236.00	38.40	7.74
100-3	31.75	19.05	19.05	9.53	110.90	114.60	55.50	59.10	29.30	4.00	35.80	354.00	56.50	11.58
100-4					147.40	150.80	73.70	77.10				471.00	74.40	15.06
100-5					183.00	186.60	91.50	95.10				590.00	88.10	19.26
100-6					218.80	222.40	109.40	113.00				708.00	104.00	23.10

KILOWATT RATING OF 100

(kw)

No. of Teeth Small Spkt.	Revolutions per Minute(RPM)-Small Sprocket																			
	10	25	50	100	150	200	300	400	500	600	700	800	900	1000	1100	1200	1300	1400	1500	1800
	Lubrication Method																			
	A			B		C						D								
11	1.27	2.90	5.41	10.10	14.50	18.80	27.10	35.10	43.00	37.60	29.90	24.40	20.50	17.50	15.20	13.30	11.80	10.60	9.50	7.20
12	1.40	3.18	5.94	11.10	16.00	20.70	29.80	38.60	47.20	42.90	34.00	27.90	23.30	19.90	17.30	15.20	13.40	12.00	10.80	8.30
13	1.52	3.47	6.48	12.10	17.40	22.60	32.50	42.10	51.50	48.40	38.40	31.40	26.30	22.50	19.50	17.10	15.20	13.60	12.20	9.30
14	1.65	3.76	7.02	13.10	18.90	24.40	35.20	45.60	55.70	54.00	42.90	35.10	29.40	25.10	21.80	19.10	16.90	15.20	13.70	10.40
15	1.78	4.05	7.56	14.10	20.30	26.30	37.90	49.10	60.10	59.90	47.60	38.90	32.60	27.90	24.10	21.20	18.80	16.80	15.20	11.50
16	1.90	4.34	8.11	15.10	21.80	28.20	40.70	52.70	64.40	66.00	52.40	42.90	35.90	30.70	26.60	23.30	20.70	18.50	16.70	12.70
17	2.03	4.64	8.65	16.10	23.30	30.10	43.40	56.20	68.70	72.30	57.40	47.00	39.40	33.60	29.10	25.60	22.70	20.30	18.30	13.90
18	2.16	4.93	9.21	17.20	24.70	32.10	46.20	59.80	73.10	78.80	62.50	51.20	42.90	36.60	31.70	27.90	24.70	22.10	19.90	15.20
19	2.29	5.23	9.76	18.20	26.20	34.00	48.90	63.40	77.50	85.40	67.80	55.50	46.50	39.70	34.40	30.20	26.80	24.00	21.60	16.40
20	2.42	5.53	10.30	19.20	27.70	35.90	51.70	67.00	81.90	92.30	73.20	59.90	50.20	42.90	37.20	32.60	28.90	25.90	23.30	17.80
21	2.55	5.83	10.90	20.30	29.20	37.90	54.50	70.70	86.40	99.30	78.80	64.50	54.00	46.10	40.00	35.10	31.10	27.90	25.10	19.10
22	2.69	6.13	11.40	21.30	30.70	39.80	57.30	74.30	90.80	106.00	84.50	69.10	57.90	49.50	42.90	37.60	33.40	29.90	26.90	20.50
23	2.82	6.43	12.00	22.40	32.20	41.80	60.20	77.90	95.30	112.00	90.30	73.90	61.90	52.90	45.80	40.20	35.70	31.90	28.80	21.90
24	2.95	6.73	12.60	23.40	33.80	43.70	63.00	81.60	99.80	118.00	96.20	78.80	66.00	56.40	48.90	42.90	38.00	34.00	30.70	23.30
25	3.08	7.03	13.10	24.50	35.30	45.70	65.80	85.30	104.00	123.00	102.00	83.80	70.20	59.90	51.90	45.60	40.40	36.20	32.60	24.80
26	3.22	7.34	13.70	25.60	36.80	47.70	68.70	89.00	109.00	128.00	109.00	88.80	74.40	63.60	55.10	48.40	42.90	38.40	34.60	26.30
28	3.48	7.95	14.80	27.70	39.90	51.70	74.40	96.40	118.00	139.00	121.00	99.30	83.20	71.00	61.60	54.00	47.90	42.90	38.70	29.40
30	3.75	8.56	16.00	29.80	43.00	55.70	80.20	104.00	127.00	150.00	135.00	110.00	92.30	78.80	68.30	59.90	53.10	47.60	42.90	32.60
32	4.03	9.18	17.10	32.00	46.10	59.70	85.90	111.00	136.00	160.00	148.00	121.00	102.00	86.80	75.20	66.00	58.50	52.40	47.20	35.90
35	4.43	10.10	18.90	35.20	50.70	65.70	94.70	123.00	150.00	177.00	170.00	139.00	116.00	99.30	86.00	75.50	67.00	59.90	54.00	41.10
40	5.12	11.70	21.80	40.70	58.60	75.90	109.00	142.00	173.00	204.00	207.00	170.00	142.00	121.00	105.00	92.30	81.80	73.20	66.00	50.20
45	5.82	13.30	24.80	46.20	66.60	86.20	124.00	161.00	197.00	232.00	247.00	202.00	170.00	145.00	125.00	110.00	97.60	87.40	78.80	59.90

Note: Lubricated types A, B, C and D on the table are shown on page 70.

: Whenever possible, selection should not be made from the colored sections of the table.

120

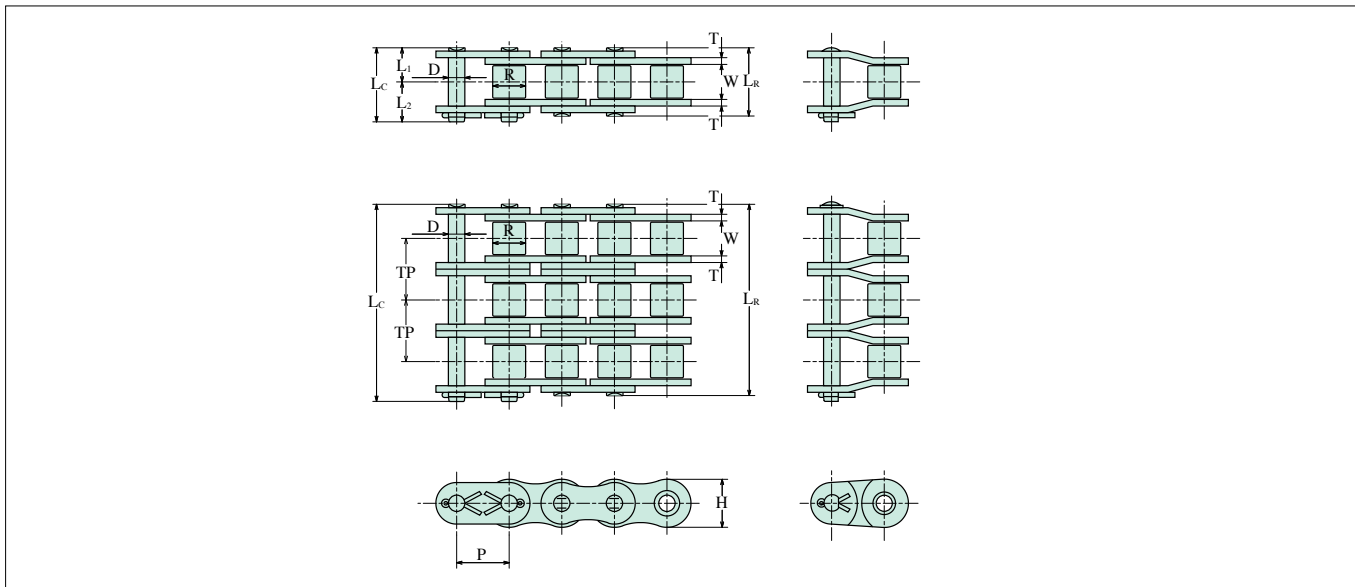

Chain No.	Dimensions - mm											Average Ultimate Strength kN	Maximum Allowable Load kN	Average Chain Weight kg/m
	Pitch P	Roller		Pin				Plate		Trans. Pitch TP				
		Width W	Dia. R	Dia. D	Length			Height H	Thick. T					
					LR	LC	L1				L2			
120					49.50	53.40	24.80	28.60			—	167.00	39.50	5.76
120-2					94.90	98.80	47.50	51.30				334.00	51.70	11.49
120-3	38.10	25.40	22.23	11.10	140.30	144.20	70.20	74.00	35.10	4.80	45.40	501.00	76.00	17.20
120-4					186.10	190.00	93.10	96.90				668.00	100.00	22.92
120-5					231.50	235.40	115.80	119.60				835.00	119.00	28.65
120-6					276.90	280.80	138.50	142.30				1002.00	140.00	34.36

KILOWATT RATING OF 120

(kw)

No. of Teeth Small Spkt.	Revolutions per Minute(RPM)-Small Sprocket																	
	10	25	50	100	150	200	300	400	500	600	700	800	900	1000	1100	1200	1300	1400
	Lubrication Method																	
	A			B			C						D					
11	2.04	4.66	8.70	16.20	23.40	30.30	43.60	56.50	57.20	43.50	34.60	28.30	23.70	20.20	17.50	15.40	13.70	12.20
12	2.24	5.12	9.55	17.80	25.70	33.30	47.90	62.10	65.20	49.60	39.40	32.20	27.00	23.10	20.00	17.50	15.60	13.90
13	2.45	5.58	10.40	19.40	28.00	36.30	52.20	67.70	73.50	55.90	44.40	36.30	30.50	26.00	22.50	19.80	17.50	15.70
14	2.65	6.05	11.30	21.10	30.30	39.30	56.60	73.30	82.20	62.50	49.60	40.60	34.00	29.10	25.20	22.10	19.60	17.50
15	2.86	6.52	12.20	22.70	32.70	42.30	61.00	79.00	91.10	69.30	55.00	45.00	37.70	32.20	27.90	24.50	21.70	19.50
16	3.06	6.99	13.00	24.30	35.00	45.40	65.40	84.70	100.00	76.40	60.60	49.60	41.60	35.50	30.80	27.00	24.00	21.40
17	3.27	7.46	13.90	26.00	37.40	48.50	69.80	90.40	110.00	83.70	66.40	54.30	45.50	38.90	33.70	29.60	26.20	23.50
18	3.48	7.93	14.80	27.60	39.80	51.60	74.30	96.20	118.00	91.10	72.30	59.20	49.60	42.40	36.70	32.20	28.60	25.60
19	3.69	8.41	15.70	29.30	42.20	54.70	78.70	102.00	125.00	98.80	78.40	64.20	53.80	45.90	39.80	34.90	31.00	27.70
20	3.90	8.89	16.60	31.00	44.60	57.80	83.20	108.00	132.00	107.00	84.70	69.30	58.10	49.60	43.00	37.70	33.50	30.00
21	4.11	9.37	17.50	32.60	47.00	60.90	87.70	114.00	139.00	115.00	91.10	74.60	62.50	53.40	46.30	40.60	36.00	32.20
22	4.32	9.85	18.40	34.30	49.40	64.00	92.20	119.00	146.00	123.00	97.70	80.00	67.00	57.20	49.60	43.50	38.60	34.60
23	4.53	10.30	19.30	36.00	51.90	67.20	96.80	125.00	153.00	132.00	104.00	85.50	71.70	61.20	53.00	46.50	41.30	36.90
24	4.75	10.80	20.20	37.70	54.30	70.30	101.00	131.00	160.00	140.00	111.00	91.10	76.40	65.20	56.50	49.60	44.00	39.40
25	4.96	11.30	21.10	39.40	56.70	73.50	106.00	137.00	168.00	149.00	118.00	96.90	81.20	69.30	60.10	52.70	46.80	41.90
26	5.17	11.80	22.00	41.10	59.20	76.70	110.00	143.00	175.00	158.00	126.00	103.00	86.10	73.50	63.70	55.90	49.60	44.40
28	5.60	12.80	23.90	44.50	64.10	83.10	120.00	155.00	190.00	177.00	140.00	115.00	96.30	82.20	71.20	62.50	55.40	49.60
30	6.04	13.80	25.70	48.00	69.10	89.50	129.00	167.00	204.00	196.00	156.00	127.00	107.00	91.10	79.00	69.30	61.50	55.00
32	6.47	14.80	27.60	51.40	74.10	96.00	138.00	179.00	219.00	216.00	171.00	140.00	118.00	100.00	87.00	76.40	67.70	60.60
35	7.13	16.30	30.40	56.70	81.60	106.00	152.00	197.00	241.00	247.00	196.00	161.00	135.00	115.00	99.60	87.40	77.50	69.30
40	8.24	18.80	35.10	65.40	94.30	122.00	176.00	228.00	279.00	302.00	240.00	196.00	164.00	140.00	122.00	107.00	94.70	84.70
45	9.36	21.30	39.80	74.30	107.00	139.00	200.00	259.00	316.00	360.00	286.00	234.00	196.00	167.00	145.00	127.00	113.00	101.00

Note: Lubricated types A, B, C and D on the table are shown on page 70.

: Whenever possible, selection should not be made from the colored sections of the table.

140

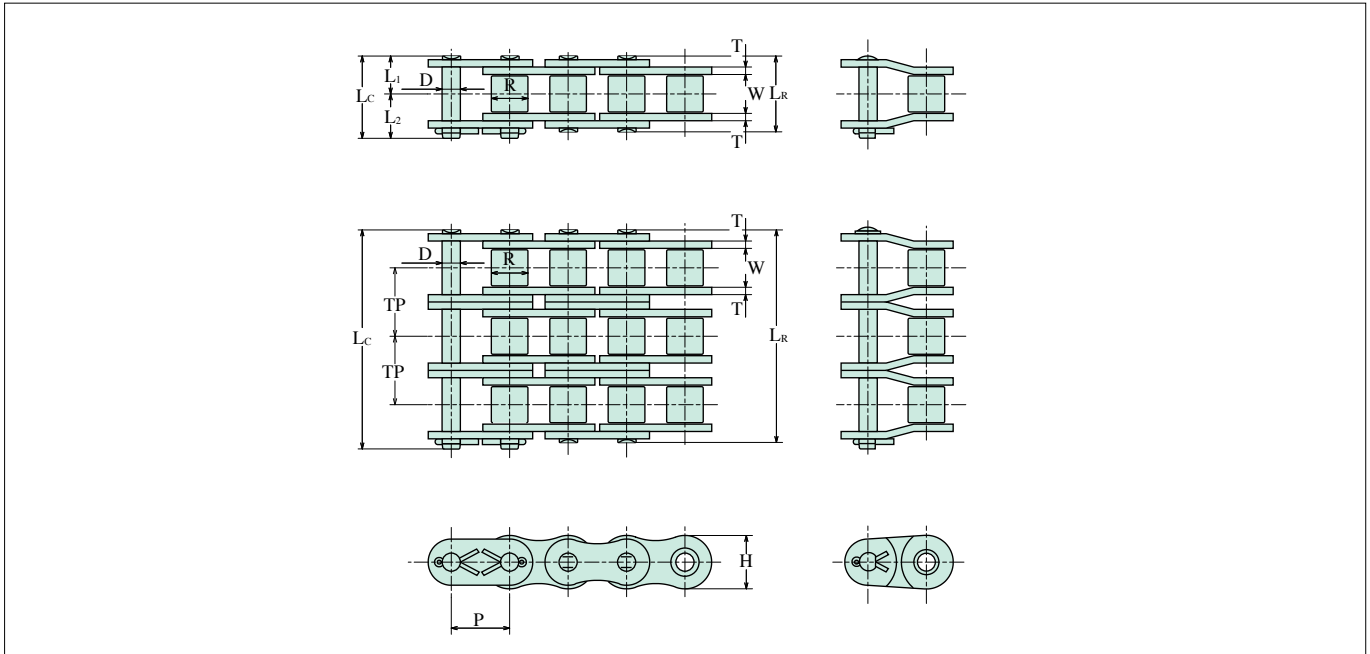

Chain No.	Dimensions - mm											Average Ultimate Strength kN	Maximum Allowable Load kN	Average Chain Weight kg/m
	Pitch P	Roller		Pin				Plate		Trans. Pitch TP				
		Width W	Dia. R	Dia. D	Length			Height H	Thick. T					
					LR	LC	L1	L2						
140					54.00	58.30	27.00	31.30			—	216.00	52.30	7.41
140-2	44.45	25.40	25.40	12.70	102.90	107.20	51.50	55.70	40.90	5.60	48.90	432.00	68.30	14.63
140-3					151.70	156.30	75.90	80.40				648.00	101.00	21.91
140-4					201.20	205.50	100.60	104.90				864.00	133.00	29.17

KILOWATT RATING OF 140

(kw)

No. of Teeth Small Spk.	Revolutions per Minute(RPM)-Small Sprocket																	
	10	25	50	100	150	200	250	300	350	400	450	500	550	600	700	800	900	1000
	Lubrication Method																	
	A		B		C						D							
11	3.16	7.21	13.50	25.10	36.20	46.90	57.30	67.50	77.50	87.40	75.80	64.80	56.10	49.30	39.10	32.00	26.80	22.90
12	3.47	7.92	14.80	27.60	39.70	51.50	62.90	74.10	85.20	96.10	86.40	73.80	64.00	56.10	44.50	36.50	30.60	26.10
13	3.79	8.64	16.10	30.10	43.30	56.10	68.60	80.80	92.90	105.00	97.40	83.20	72.10	63.30	50.20	41.10	34.40	29.40
14	4.10	9.36	17.50	32.60	46.90	60.80	74.30	87.60	101.00	113.00	109.00	93.00	80.60	70.70	56.10	45.90	38.50	32.90
15	4.42	10.10	18.80	35.10	50.60	65.50	80.10	94.40	108.00	122.00	121.00	103.00	89.40	78.40	62.20	50.90	42.70	36.50
16	4.74	10.80	20.20	37.60	54.20	70.20	85.90	101.00	116.00	131.00	133.00	114.00	98.50	86.40	68.60	56.10	47.00	40.20
17	5.06	11.50	21.50	40.20	57.90	75.00	91.70	108.00	124.00	140.00	146.00	124.00	108.00	94.60	75.10	61.50	51.50	44.00
18	5.38	12.30	22.90	42.70	61.60	79.80	97.50	115.00	132.00	149.00	159.00	136.00	117.00	103.00	81.80	67.00	56.10	47.90
19	5.70	13.00	24.30	45.30	65.30	84.60	103.00	122.00	140.00	158.00	172.00	147.00	127.00	112.00	88.70	72.60	60.90	52.00
20	6.03	13.80	25.70	47.90	69.00	89.40	109.00	129.00	148.00	167.00	185.00	159.00	138.00	121.00	95.80	78.40	65.70	56.10
21	6.36	14.50	27.10	50.50	72.70	94.20	115.00	136.00	156.00	176.00	195.00	171.00	148.00	130.00	103.00	84.40	70.70	60.40
22	6.68	15.20	28.40	53.10	76.50	99.10	121.00	143.00	164.00	185.00	206.00	183.00	159.00	139.00	111.00	90.50	75.80	64.80
23	7.01	16.00	29.80	55.70	80.20	104.00	127.00	150.00	172.00	194.00	216.00	196.00	170.00	149.00	118.00	96.70	81.10	69.20
24	7.34	16.70	31.30	58.30	84.00	109.00	133.00	157.00	180.00	203.00	226.00	209.00	181.00	159.00	126.00	103.00	86.40	73.80
25	7.67	17.50	32.70	60.90	87.80	114.00	139.00	164.00	188.00	212.00	236.00	222.00	192.00	169.00	134.00	110.00	91.90	78.40
26	8.00	18.30	34.10	63.60	91.60	119.00	145.00	171.00	196.00	221.00	246.00	235.00	204.00	179.00	142.00	116.00	97.40	83.20
28	8.67	19.80	36.90	68.90	99.20	129.00	157.00	185.00	213.00	240.00	267.00	263.00	228.00	200.00	159.00	130.00	109.00	93.00
30	9.34	21.30	39.80	74.20	107.00	138.00	169.00	199.00	229.00	258.00	287.00	292.00	253.00	222.00	176.00	144.00	121.00	103.00
32	10.00	22.80	42.60	79.60	115.00	148.00	182.00	214.00	246.00	277.00	308.00	321.00	278.00	244.00	194.00	159.00	133.00	114.00
35	11.00	25.20	47.00	87.70	126.00	164.00	200.00	236.00	271.00	305.00	339.00	368.00	319.00	280.00	222.00	182.00	152.00	130.00
40	12.70	29.10	54.30	101.00	146.00	189.00	231.00	272.00	313.00	353.00	392.00	431.00	389.00	342.00	271.00	222.00	186.00	159.00
45	14.50	33.00	61.60	115.00	166.00	215.00	262.00	309.00	355.00	400.00	445.00	489.00	464.00	408.00	323.00	265.00	222.00	189.00

Note: Lubricated types A, B, C and D on the table are shown on page 70.

: Whenever possible, selection should not be made from the colored sections of the table.

160

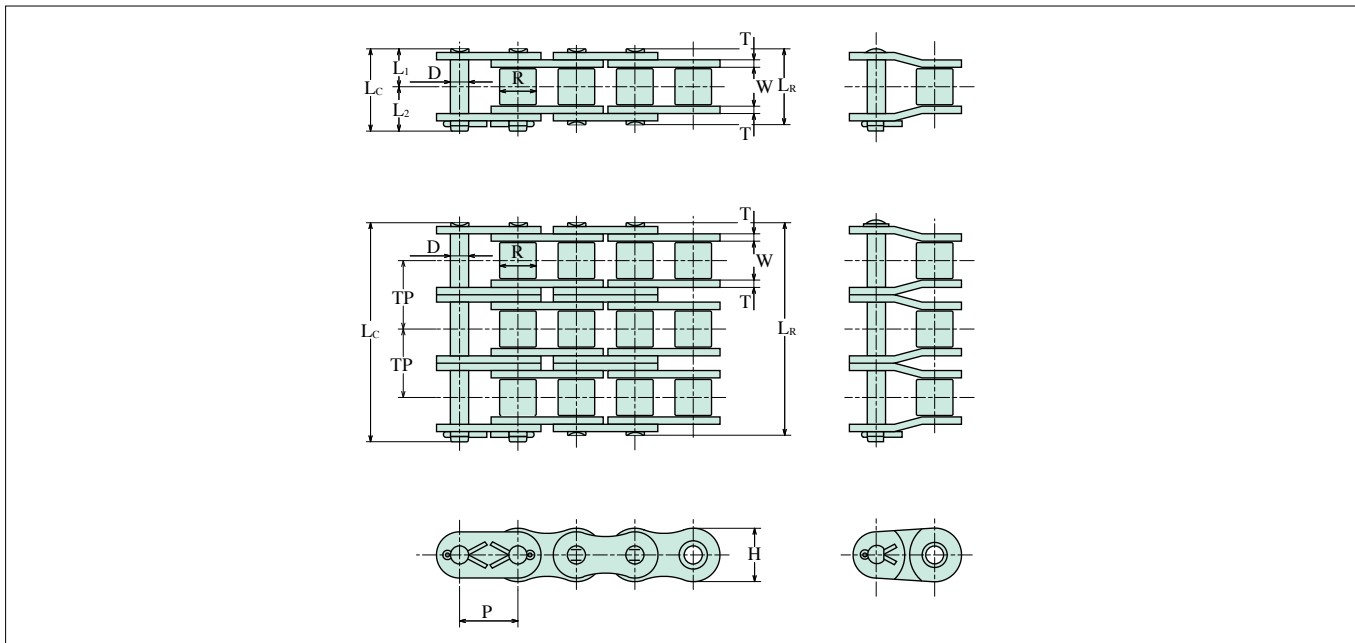

Chain No.	Dimensions - mm											Average Ultimate Strength	Maximum Allowable Load	Average Chain Weight
	Pitch	Roller		Pin				Plate		Trans. Pitch				
		Width	Dia.	Dia.	Length			Height	Thick.					
P	W	R	D	LR	LC	L1	L2	H	T	TP	kN	kN	kg/m	
160					64.30	68.70	32.20	36.50			—	275.00	69.00	9.79
160-2	50.80	31.75	28.58	14.28	122.80	127.20	61.40	65.80	46.70	6.40	58.50	550.00	90.10	19.45
160-3					181.30	185.70	90.70	95.00				825.00	133.00	29.17
160-4					240.30	244.70	120.20	124.50				1100.00	175.00	38.77

KILOWATT RATING OF 160

(kw)

No. of Teeth Small Splt.	Revolutions per Minute(RPM)-Small Sprocket																	
	10	25	50	100	150	200	250	300	350	400	450	500	550	600	650	700	750	800
	Lubrication Method																	
	A		B		C						D							
11	4.80	10.90	20.30	37.80	54.40	70.50	86.20	102.00	117.00	101.00	84.40	72.10	62.50	54.80	48.60	43.50	39.20	35.60
12	5.20	11.90	22.30	41.50	59.80	77.50	94.70	112.00	128.00	115.00	96.20	82.10	71.20	62.50	55.40	49.60	44.70	40.60
13	5.70	13.00	24.30	45.30	65.20	84.50	103.00	122.00	140.00	129.00	108.00	92.60	80.20	70.40	62.50	55.90	50.40	45.70
14	6.20	14.10	26.30	49.00	70.60	91.50	112.00	132.00	151.00	145.00	121.00	103.00	89.70	78.70	69.80	62.50	56.30	51.10
15	6.70	15.20	28.30	52.80	76.10	98.60	121.00	142.00	163.00	160.00	134.00	115.00	99.00	87.30	77.40	69.30	62.50	56.70
16	7.10	16.30	30.40	56.70	81.60	106.00	129.00	152.00	175.00	177.00	148.00	126.00	110.00	96.20	85.30	76.30	68.80	62.50
17	7.60	17.40	32.40	60.50	87.10	113.00	138.00	163.00	187.00	193.00	162.00	138.00	120.00	105.00	93.40	83.60	75.40	68.40
18	8.10	18.50	34.50	64.30	92.70	120.00	147.00	173.00	199.00	211.00	177.00	151.00	131.00	115.00	102.00	91.00	82.10	74.50
19	8.60	19.60	36.60	68.20	98.20	127.00	156.00	183.00	211.00	229.00	192.00	164.00	142.00	124.00	110.00	98.70	89.00	80.80
20	9.10	20.70	38.60	72.10	104.00	135.00	164.00	194.00	223.00	247.00	207.00	177.00	153.00	134.00	119.00	107.00	96.20	87.30
21	9.60	21.80	40.70	76.00	109.00	142.00	173.00	204.00	235.00	265.00	223.00	190.00	165.00	145.00	128.00	115.00	103.00	93.90
22	10.10	22.90	42.80	79.90	115.00	149.00	182.00	215.00	247.00	278.00	239.00	204.00	177.00	155.00	137.00	123.00	111.00	101.00
23	10.60	24.10	44.90	83.80	121.00	156.00	191.00	225.00	259.00	292.00	255.00	218.00	189.00	166.00	147.00	132.00	119.00	108.00
24	11.10	25.20	47.00	87.80	126.00	164.00	200.00	236.00	271.00	306.00	272.00	232.00	201.00	177.00	157.00	140.00	126.00	115.00
25	11.50	26.30	49.20	91.70	132.00	171.00	209.00	247.00	283.00	319.00	289.00	247.00	214.00	188.00	167.00	149.00	134.00	122.00
26	12.00	27.50	51.30	95.70	138.00	179.00	218.00	257.00	296.00	333.00	307.00	262.00	227.00	199.00	177.00	158.00	143.00	129.00
28	13.10	29.80	55.60	104.00	149.00	193.00	237.00	279.00	320.00	361.00	343.00	293.00	254.00	223.00	197.00	177.00	159.00	145.00
30	14.10	32.10	59.90	112.00	161.00	208.00	255.00	300.00	345.00	389.00	380.00	325.00	281.00	247.00	219.00	196.00	177.00	160.00
32	15.10	34.40	64.20	120.00	173.00	223.00	273.00	322.00	370.00	417.00	419.00	358.00	310.00	272.00	241.00	216.00	195.00	177.00
35	16.60	37.90	70.70	132.00	190.00	246.00	301.00	355.00	407.00	459.00	479.00	409.00	354.00	311.00	276.00	247.00	223.00	202.00
40	19.20	43.80	81.70	152.00	220.00	284.00	348.00	410.00	471.00	531.00	585.00	500.00	433.00	380.00	337.00	302.00	272.00	247.00
45	21.80	49.70	92.70	173.00	249.00	323.00	395.00	465.00	534.00	603.00	670.00	596.00	517.00	454.00	402.00	360.00	325.00	295.00

Note: Lubricated types A, B, C and D on the table are shown on page 70.

: Whenever possible, selection should not be made from the colored sections of the table.

180

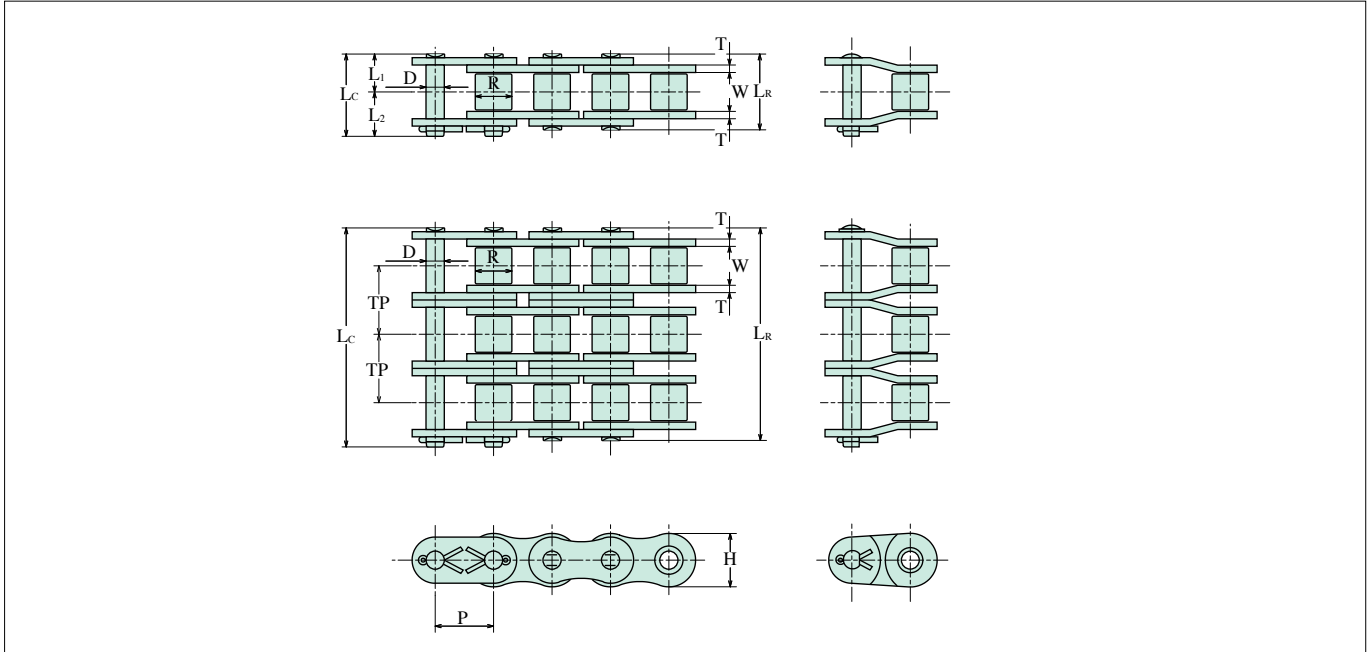

Chain No.	Dimensions - mm											Average Ultimate Strength	Maximum Allowable Load	Average Chain Weight
	Pitch	Roller		Pin				Plate		Trans. Pitch				
		Width	Dia.	Dia.	Length			Height	Thick.					
		P	W	R	D	LR	LC	L1	L2		H			
180					72.50	78.40	36.30	42.10			—	353.00	79.00	13.39
180-2	57.15	35.70	35.70	17.45	138.20	144.00	69.10	74.90	52.50	7.20	65.80	706.00	98.40	26.62
180-3					204.50	210.20	102.30	107.90				1059.00	145.00	39.85
180-4					270.20	275.90	135.10	140.80				1412.00	191.00	53.08

KILOWATT RATING OF 180

(kw)

No. of Teeth Small Spkt.	Revolutions per Minute(RPM)-Small Sprocket																	
	10	25	50	100	150	200	250	300	350	400	450	500	550	600	650	700	750	800
	Lubrication Method																	
	A	B	C						D									
9	5.10	11.60	21.70	40.50	58.34	75.60	92.40	109.00	100.00	81.90	68.60	58.60	50.80	44.60	39.50	35.40	31.90	29.00
10	5.70	13.00	24.30	45.40	65.37	84.70	104.00	122.00	117.00	95.90	80.40	68.60	59.50	52.20	46.30	41.40	37.40	33.90
11	6.30	14.40	27.00	50.30	72.46	93.90	115.00	135.00	135.00	111.00	92.70	79.20	68.60	60.20	53.40	47.80	43.10	39.10
12	7.00	15.90	29.60	55.30	79.60	103.00	126.00	149.00	154.00	126.00	106.00	90.20	78.20	68.60	60.90	54.50	49.10	44.60
13	7.60	17.30	32.30	60.30	86.79	112.00	137.00	162.00	174.00	142.00	119.00	102.00	88.20	77.40	68.60	61.40	55.40	50.30
14	8.20	18.70	35.00	65.30	94.02	122.00	149.00	175.00	194.00	159.00	133.00	114.00	98.50	86.50	76.70	68.60	61.90	56.20
15	8.90	20.20	37.70	70.30	101.00	131.00	160.00	189.00	215.00	176.00	148.00	126.00	109.00	95.90	85.10	76.10	68.60	62.30
16	9.50	21.70	40.40	75.40	109.00	141.00	172.00	203.00	233.00	194.00	163.00	139.00	120.00	106.00	93.70	83.80	75.60	68.60
17	10.10	23.10	43.70	80.50	116.00	150.00	184.00	216.00	249.00	213.00	178.00	152.00	132.00	116.00	103.00	91.80	82.80	75.20
18	10.80	24.60	45.90	85.60	123.00	160.00	195.00	230.00	264.00	232.00	194.00	166.00	144.00	126.00	112.00	100.00	90.20	81.90
19	11.40	26.10	48.60	90.80	131.00	169.00	207.00	244.00	280.00	251.00	210.00	180.00	156.00	137.00	121.00	108.00	97.80	88.80
20	12.10	27.60	51.40	95.90	138.00	179.00	219.00	258.00	296.00	271.00	227.00	194.00	168.00	148.00	131.00	117.00	106.00	95.90
21	12.70	29.00	54.20	101.00	146.00	189.00	231.00	272.00	312.00	292.00	245.00	209.00	181.00	159.00	141.00	126.00	114.00	103.00
22	13.40	30.50	57.00	106.00	153.00	198.00	243.00	286.00	328.00	313.00	262.00	224.00	194.00	170.00	151.00	135.00	122.00	111.00
23	14.00	32.00	59.80	112.00	161.00	208.00	255.00	300.00	345.00	335.00	280.00	239.00	207.00	182.00	161.00	145.00	130.00	118.00
24	14.70	33.50	62.60	117.00	168.00	218.00	266.00	314.00	361.00	357.00	299.00	255.00	221.00	194.00	172.00	154.00	139.00	126.00
25	15.40	35.10	65.40	122.00	176.00	228.00	279.00	328.00	377.00	379.00	318.00	271.00	235.00	206.00	183.00	164.00	148.00	134.00
26	16.00	36.60	68.30	127.00	183.00	238.00	291.00	342.00	393.00	402.00	337.00	288.00	249.00	219.00	194.00	174.00	157.00	142.00
28	17.40	39.60	73.90	138.00	199.00	257.00	315.00	371.00	426.00	449.00	377.00	322.00	279.00	245.00	217.00	194.00	175.00	159.00
30	18.70	42.70	79.70	149.00	214.00	277.00	339.00	400.00	459.00	498.00	418.00	357.00	309.00	271.00	241.00	215.00	194.00	176.00
32	20.10	45.80	85.40	159.00	230.00	297.00	364.00	428.00	492.00	549.00	460.00	393.00	340.00	299.00	265.00	237.00	214.00	194.00
35	22.10	50.40	94.10	176.00	253.00	328.00	401.00	472.00	542.00	611.00	526.00	449.00	389.00	342.00	303.00	271.00	245.00	222.00
40	25.50	58.20	109.00	203.00	292.00	378.00	463.00	545.00	626.00	706.00	643.00	549.00	476.00	418.00	370.00	331.00	299.00	271.00
45	29.00	66.10	123.00	230.00	332.00	430.00	525.00	619.00	711.00	802.00	767.00	655.00	568.00	498.00	442.00	395.00	357.00	324.00

Note: Lubricated types A, B, C and D on the table are shown on page 70.

: Whenever possible, selection should not be made from the colored sections of the table.

200

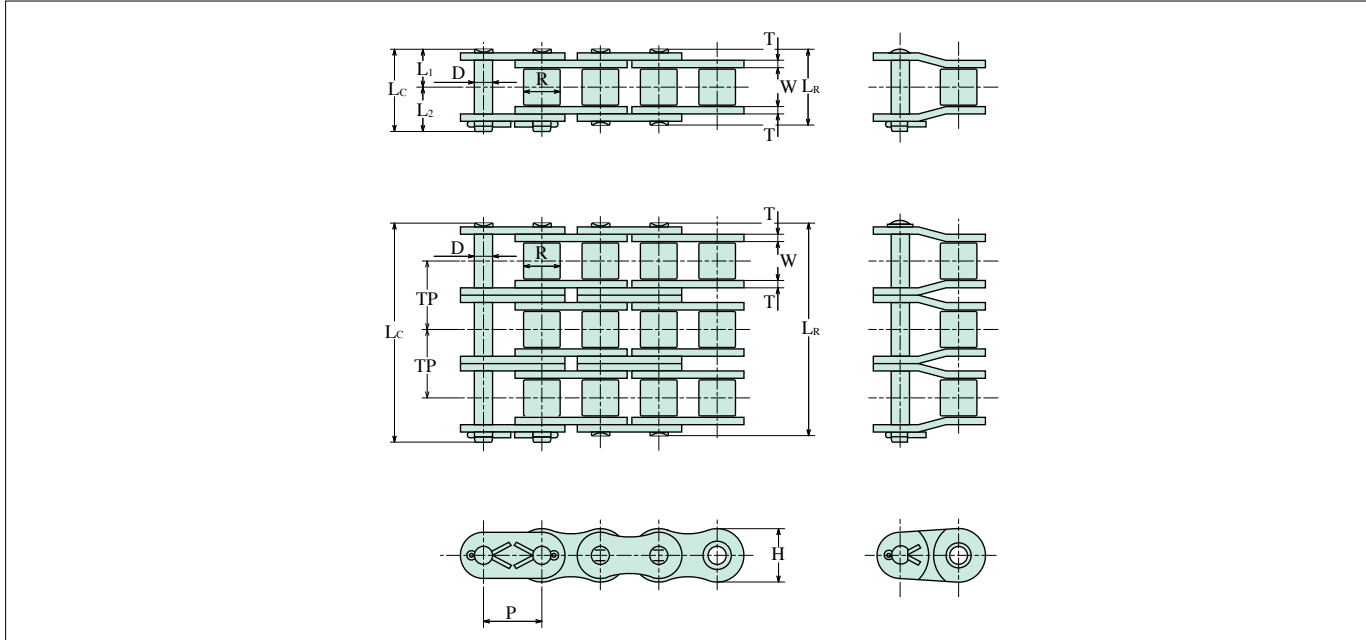

Chain No.	Dimensions - mm											Average Ultimate Strength kN	Maximum Allowable Load kN	Average Chain Weight kg/m
	Pitch P	Roller		Pin				Plate		Trans. Pitch TP				
		Width W	Dia. R	Dia. D	Length		Height H	Thick. T						
				LR	LC	L1	L2							
200					78.50	87.00	39.30	47.70			—	451.00	93.00	16.93
200-2	63.50	38.10	39.68	19.84	150.20	158.70	75.10	83.60	59.50	8.00	71.60	902.00	122.00	33.73
200-3					221.70	230.20	110.90	119.30				1353.00	179.00	50.53
200-4					293.30	302.40	146.70	155.70				1804.00	236.00	67.34

KILOWATT RATING OF 200

(kw)

No. of Teeth Small Spkt.	Revolutions per Minute(RPM)-Small Sprocket																	
	10	15	20	30	40	50	70	100	150	200	250	300	350	400	450	500	550	600
	Lubrication Method																	
	A			B				C					D					
9	6.80	9.80	12.60	18.20	23.60	28.80	39.00	53.78	77.50	100.00	123.00	137.00	109.00	89.10	74.70	63.70	55.30	48.50
10	7.60	10.90	14.20	20.40	26.40	32.30	43.70	60.26	86.80	112.00	137.00	161.00	127.00	104.00	87.40	74.70	64.70	56.80
11	8.40	12.10	15.70	22.60	29.30	35.80	48.50	66.79	96.20	125.00	152.00	180.00	147.00	120.00	101.00	86.10	74.70	65.50
12	9.20	13.30	17.20	24.80	32.20	39.30	53.20	73.37	106.00	137.00	167.00	197.00	168.00	137.00	115.00	98.10	85.10	74.70
13	10.10	14.50	18.80	27.10	35.10	42.90	58.00	80.00	115.00	149.00	182.00	215.00	189.00	155.00	130.00	111.00	95.90	84.20
14	10.90	15.70	20.40	29.30	38.00	46.40	62.90	86.66	125.00	162.00	198.00	233.00	211.00	173.00	145.00	124.00	107.00	94.10
15	11.80	16.90	21.90	31.60	40.90	50.00	67.70	93.37	134.00	174.00	213.00	251.00	234.00	192.00	161.00	137.00	119.00	104.00
16	12.60	18.20	23.50	33.90	43.90	53.60	72.60	100.00	144.00	187.00	228.00	269.00	258.00	211.00	177.00	151.00	131.00	115.00
17	13.50	19.40	25.10	36.20	46.90	57.30	77.50	107.00	154.00	199.00	244.00	287.00	283.00	231.00	194.00	165.00	143.00	126.00
18	14.30	20.60	26.70	38.50	49.80	60.90	82.50	114.00	164.00	212.00	259.00	306.00	308.00	252.00	211.00	180.00	156.00	137.00
19	15.20	21.90	28.30	40.80	52.80	64.60	87.40	121.00	174.00	225.00	275.00	324.00	334.00	273.00	229.00	196.00	169.00	149.00
20	16.00	23.10	29.90	43.10	55.80	68.30	92.40	127.00	183.00	238.00	291.00	342.00	361.00	295.00	247.00	211.00	183.00	161.00
21	16.90	24.30	31.50	45.40	58.90	72.00	97.40	134.00	193.00	251.00	306.00	361.00	388.00	318.00	266.00	227.00	197.00	173.00
22	17.80	25.60	33.20	47.80	61.90	75.70	102.00	141.00	203.00	263.00	322.00	380.00	416.00	340.00	285.00	244.00	211.00	185.00
23	18.60	26.90	34.80	50.10	64.90	79.40	107.00	148.00	213.00	276.00	338.00	398.00	445.00	364.00	305.00	260.00	226.00	198.00
24	19.50	28.10	36.40	52.50	68.00	83.10	113.00	155.00	223.00	289.00	354.00	417.00	474.00	388.00	325.00	278.00	241.00	211.00
25	20.40	29.40	38.10	54.90	71.10	86.90	118.00	162.00	233.00	302.00	370.00	436.00	501.00	412.00	346.00	295.00	256.00	225.00
26	21.30	30.70	39.70	57.20	74.10	90.60	123.00	169.00	244.00	316.00	386.00	455.00	522.00	437.00	367.00	313.00	271.00	238.00

Note: Lubricated types A, B, C and D on the table are shown on page 70.

: Whenever possible, selection should not be made from the colored sections of the table.

240

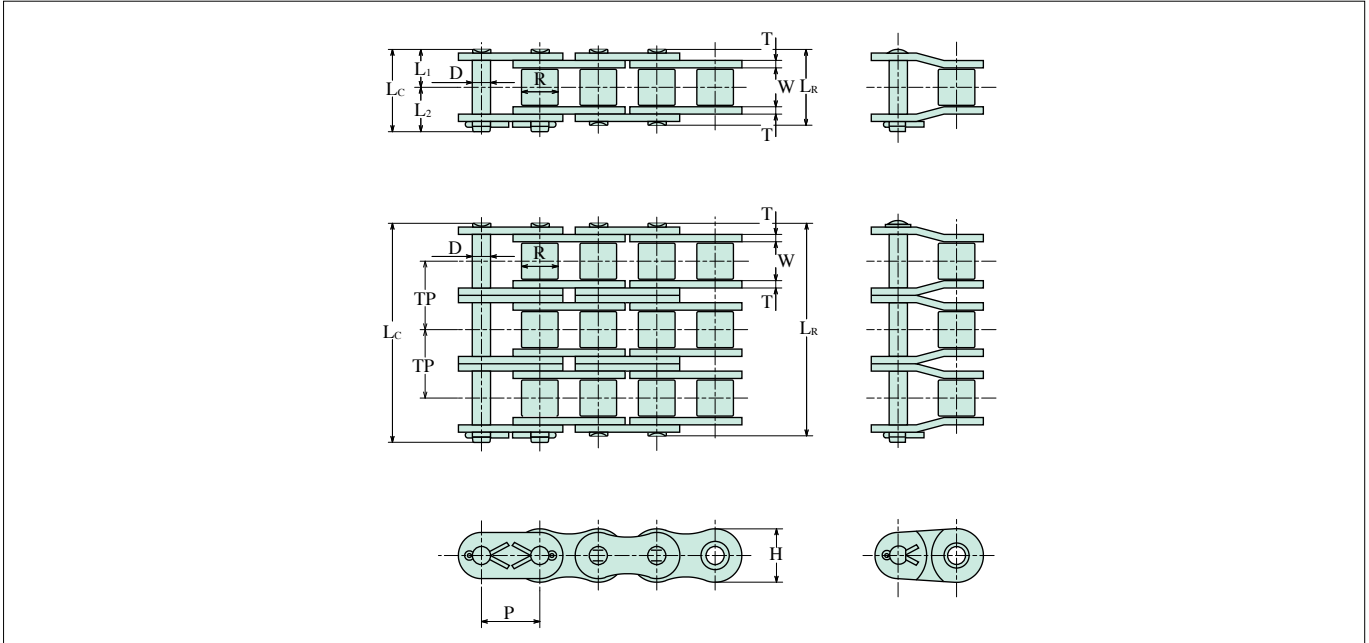

Chain No.	Dimensions - mm											Average Ultimate Strength	Maximum Allowable Load	Average Chain Weight
	Pitch	Roller		Pin				Plate		Trans. Pitch				
		Width	Dia.	Dia.	Length			Height	Thick.					
	P	W	R	D	LR	LC	L1	L2	H	T	TP			
240					96.40	104.10	48.20	55.90			—	677.00	129.00	23.64
240-2	76.20	47.63	47.63	23.80	184.20	191.80	92.10	99.70	70.30	9.50	87.80	1354.00	167.00	47.13
240-3					272.00	279.60	136.00	143.60				2031.00	245.00	70.61
240-4					359.80	367.40	179.90	187.50				2708.00	324.00	94.09

KILOWATT RATING OF 240

(kw)

No. of Teeth Small Spkt	Revolutions per Minute(RPM)-Small Sprocket																	
	5	10	15	20	25	30	40	50	60	80	100	125	150	175	200	250	300	350
	Lubrication Method																	
	A				B				C				D					
9	5.80	10.90	15.70	20.30	24.90	29.30	38.00	46.40	54.70	70.90	86.60	106.00	125.00	143.00	162.00	198.00	159.00	126.00
10	6.50	12.20	17.60	22.80	27.90	32.80	42.50	52.00	61.30	79.40	97.10	119.00	140.00	161.00	181.00	221.00	186.00	147.00
11	7.30	13.50	19.50	25.30	30.90	36.40	47.20	57.60	67.90	88.00	108.00	131.00	155.00	178.00	201.00	245.00	241.00	170.00
12	8.00	14.90	21.40	27.80	33.90	40.00	51.80	63.30	74.60	96.70	118.00	144.00	170.00	196.00	221.00	270.00	244.00	194.00
13	8.70	16.20	23.40	30.30	37.00	43.60	56.50	69.00	81.40	105.00	129.00	157.00	186.00	213.00	240.00	294.00	275.00	219.00
14	9.40	17.60	25.30	32.80	40.10	47.20	61.20	74.80	88.10	114.00	140.00	171.00	201.00	231.00	260.00	318.00	308.00	244.00
15	10.10	18.90	27.30	35.30	43.20	50.90	65.90	80.60	95.00	123.00	150.00	184.00	217.00	249.00	281.00	343.00	341.00	271.00
16	10.90	20.30	29.20	37.90	46.30	54.60	70.70	86.40	102.00	132.00	161.00	197.00	232.00	267.00	301.00	368.00	376.00	299.00
17	11.60	21.70	31.20	40.40	49.40	58.20	75.50	92.20	109.00	141.00	172.00	210.00	248.00	285.00	321.00	393.00	412.00	327.00
18	12.40	23.10	33.20	43.00	52.60	62.00	80.30	98.10	116.00	150.00	183.00	224.00	264.00	303.00	342.00	418.00	449.00	356.00
19	13.10	24.40	35.20	45.60	55.70	65.70	85.10	104.00	123.00	159.00	194.00	237.00	280.00	321.00	362.00	443.00	487.00	386.00
20	13.80	25.80	37.20	48.20	58.90	69.40	89.90	110.00	130.00	168.00	205.00	251.00	296.00	340.00	383.00	468.00	526.00	417.00
21	14.60	27.20	39.20	50.80	62.10	73.20	94.80	116.00	137.00	177.00	216.00	264.00	312.00	358.00	404.00	493.00	566.00	449.00
22	15.30	28.60	41.20	53.40	65.30	77.00	99.70	122.00	144.00	186.00	227.00	278.00	328.00	376.00	424.00	519.00	607.00	481.00
23	16.10	30.00	43.30	56.10	68.50	80.70	105.00	128.00	151.00	195.00	239.00	292.00	344.00	395.00	445.00	544.00	641.00	514.00
24	16.90	31.50	45.30	58.70	71.70	84.50	110.00	134.00	158.00	204.00	250.00	305.00	360.00	413.00	466.00	570.00	671.00	548.00
25	17.60	32.90	47.30	61.30	75.00	88.30	114.00	140.00	165.00	214.00	261.00	319.00	376.00	432.00	487.00	596.00	702.00	583.00
26	18.40	34.30	49.40	64.00	78.20	92.20	119.00	146.00	172.00	223.00	272.00	333.00	392.00	451.00	508.00	621.00	732.00	618.00

Note: Lubricated types A, B, C and D on the table are shown on page 70.

: Whenever possible, selection should not be made from the colored sections of the table.

BS Standard Roller Chains

06B

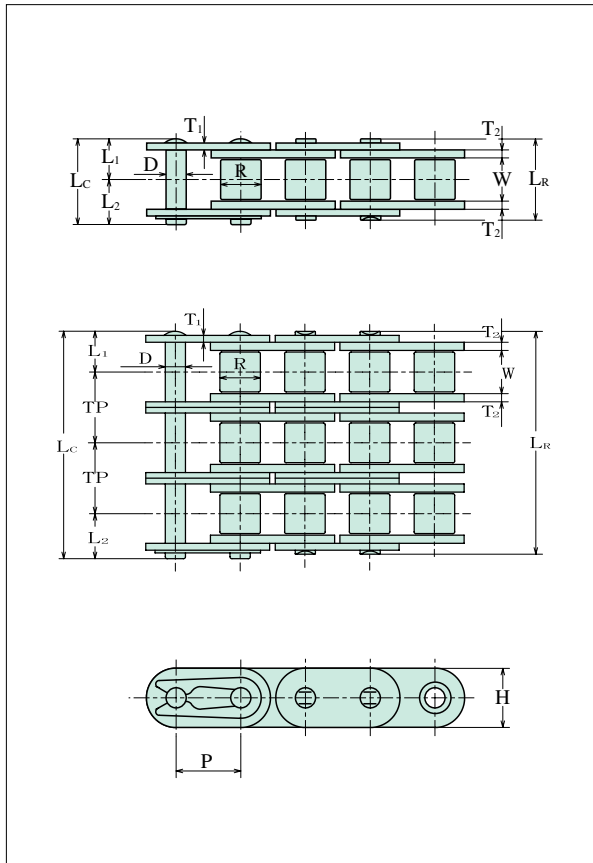

08B.10B.12B.16B

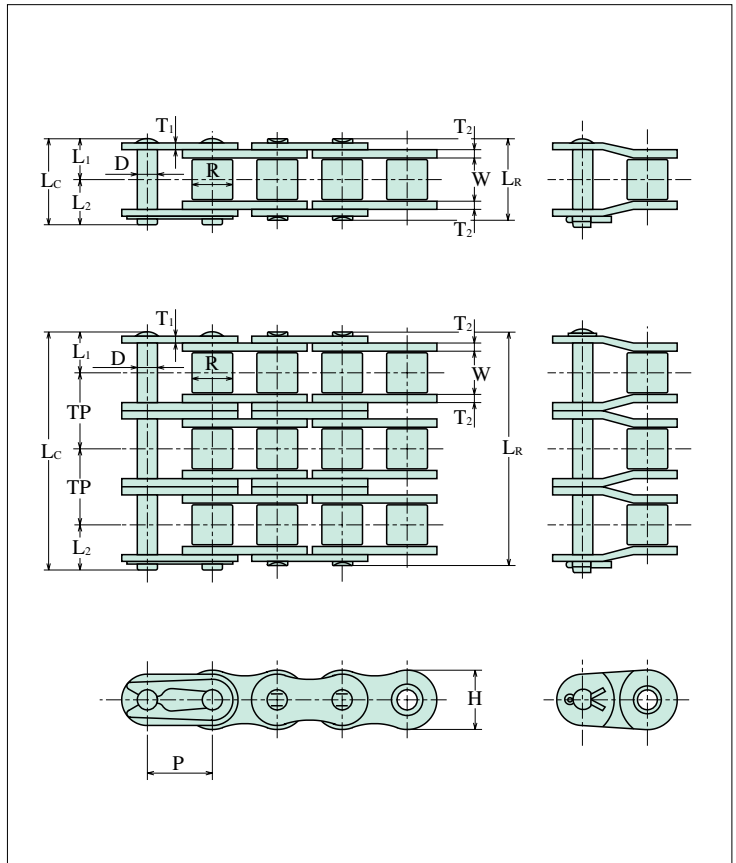

Chain No.	Dimensions - mm												Minimum Ultimate Strength	Maximum Allowable Load	Average Chain Weight
	Pitch	Roller		Pin				Plate		Trans. Pitch					
		Width	Dia.	Dia.	Length		Height	Thickness							
P	W	R	D	LR	LC	L1	L2	H	T1	T2	TP	kN	kN	kg/m	
※06B					12.60	13.40							8.90	1.77	0.39
※ -2	9.525	5.72	6.35	3.28	22.90	23.70	6.30	7.10	8.26	1.30	1.00	10.24	16.90	2.90	0.74
※ -3					33.20	33.70							24.90	4.20	1.10
08B					16.70	18.20							17.80	3.14	0.61
-2	12.70	7.75	8.51	4.45	30.60	31.90	8.40	9.80	11.80	1.50		13.92	31.10	5.35	1.26
-3					44.50	45.80							44.50	7.85	1.88
10B					19.00	20.70							22.20	4.90	0.89
-2	15.875	9.65	10.16	5.08	35.60	37.30	9.50	11.20	14.70	1.65		16.59	44.50	8.33	1.79
-3					52.40	54.40							66.70	12.20	2.66
12B					22.00	23.60							28.90	7.06	1.14
-2	19.05	11.68	12.07	5.72	41.60	43.10	11.00	12.60	16.10	1.80		19.46	57.80	12.00	2.28
-3					61.10	62.70							86.70	17.60	3.36
16B					35.10	38.20							60.00	16.40	2.59
-2	25.40	17.02	15.88	8.26	67.20	70.10	17.60	20.60	21.00	3.20	4.00	31.88	106.00	21.40	5.13
-3					99.20	102.50							160.00	31.50	7.68

Note: ※Curled bushing is used

20B.24B.28B.32B

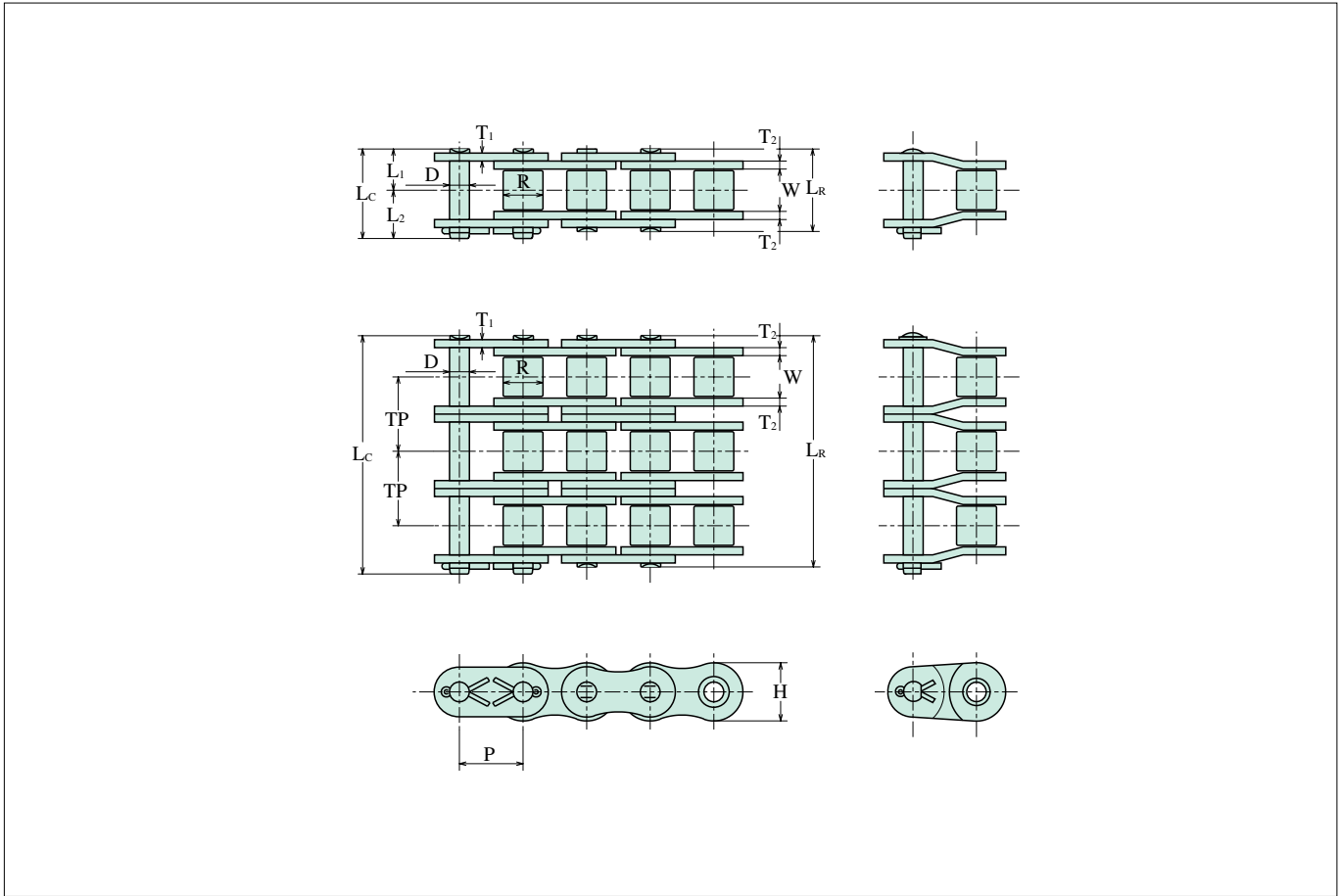

Chain No.	Dimensions - mm												Minimum Ultimate Strength	Maximum Allowable Load	Average Chain Weight
	Pitch	Roller		Pin				Plate		Trans. Pitch					
		Width	Dia.	Dia.	Length		Height	Thickness							
	P	W	R	D	L _R	L _C	L ₁	L ₂	H	T ₁	T ₂	TP			
20B					40.20	44.00							95.00	25.50	3.76
-2	31.75	19.56	19.05	10.16	76.80	80.60	20.10	23.90	26.40	3.50	4.50	36.45	170.00	33.30	7.26
-3					113.30	117.20							250.00	49.00	10.86
24B					53.40	58.10							160.00	35.70	7.29
-2	38.10	25.40	25.40	14.63	101.80	106.50	26.70	31.40	33.40	4.90	5.90	48.36	280.00	46.80	14.53
-3					150.20	154.90							425.00	68.80	21.76
28B					65.10	70.50							200.00	44.50	9.26
-2	44.45	31.00	27.94	15.88	124.70	130.00	32.60	37.90	37.00	6.30	7.40	59.56	360.00	58.30	18.45
-3					184.20	189.60							530.00	85.80	27.65
32B					65.00	71.10							250.00	51.00	9.92
-2	50.80	31.00	29.21	17.81	123.40	129.70	32.50	38.60	42.20	6.30	6.90	58.55	450.00	66.60	19.76
-3					182.00	188.30							670.00	98.00	29.61

Heavy Series Roller Chains (H Series)

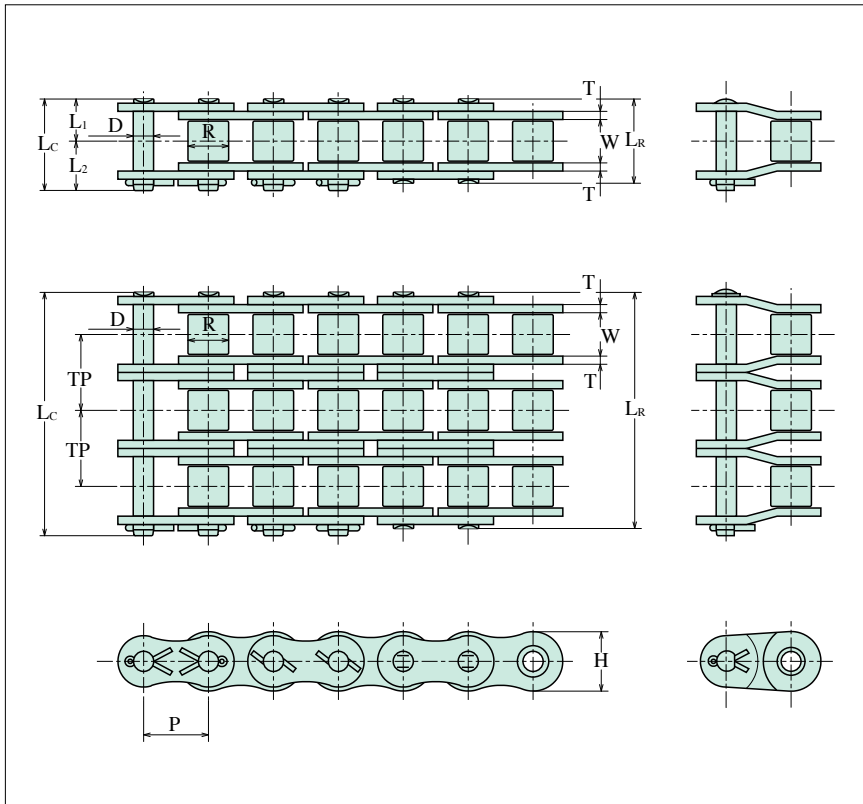

H Series Roller Chains are made of thicker steel than the standard type, and the pins are made of special alloy steel, making Type-H chains stronger and more fatigue-resistant than the standard type.

Chain No.	Dimensions - mm										Average Ultimate Strength kN	Maximum Allowable Load kN	Average Chain Weight kg/m	Type of Conn Link
	Pitch P	Roller		Pin				Plate						
		Width W	Dia. R	Dia. D	Length			Height H	Thick. T					
60H	19.05	12.70	11.91	5.95	28.80	30.80	14.40	16.40	17.50	3.20	54.90	10.70	1.80	C
80H	25.40	15.88	15.88	7.93	35.70	38.70	17.90	20.80	23.40	4.00	90.20	18.40	2.81	
100H	31.75	19.05	19.05	9.53	42.40	45.90	21.20	24.70	29.30	4.80	137.00	28.30	4.14	
120H	38.10	25.40	22.23	11.10	52.80	57.20	26.40	30.80	35.10	5.60	186.00	38.00	5.83	
140H	44.45	25.40	25.40	12.70	57.20	61.80	28.60	33.20	40.90	6.40	241.00	50.30	8.41	
160H	50.80	31.75	28.58	14.28	67.90	73.00	34.00	39.00	46.70	7.20	306.00	66.30	10.86	
180H	57.15	35.70	35.70	17.45	75.60	81.50	37.80	43.70	52.50	8.00	373.00	70.70	15.18	
200H	63.50	38.10	39.67	19.83	84.80	93.40	42.40	51.00	59.80	9.50	520.00	82.30	17.85	S
240H	76.20	47.63	47.63	23.78	109.80	118.20	54.90	63.30	72.40	12.70	726.00	112.80	32.29	

Note: ※Standard sprockets can only be used with single Strand type
 ※Type of Conn Link is referred to page 8.

HE Series

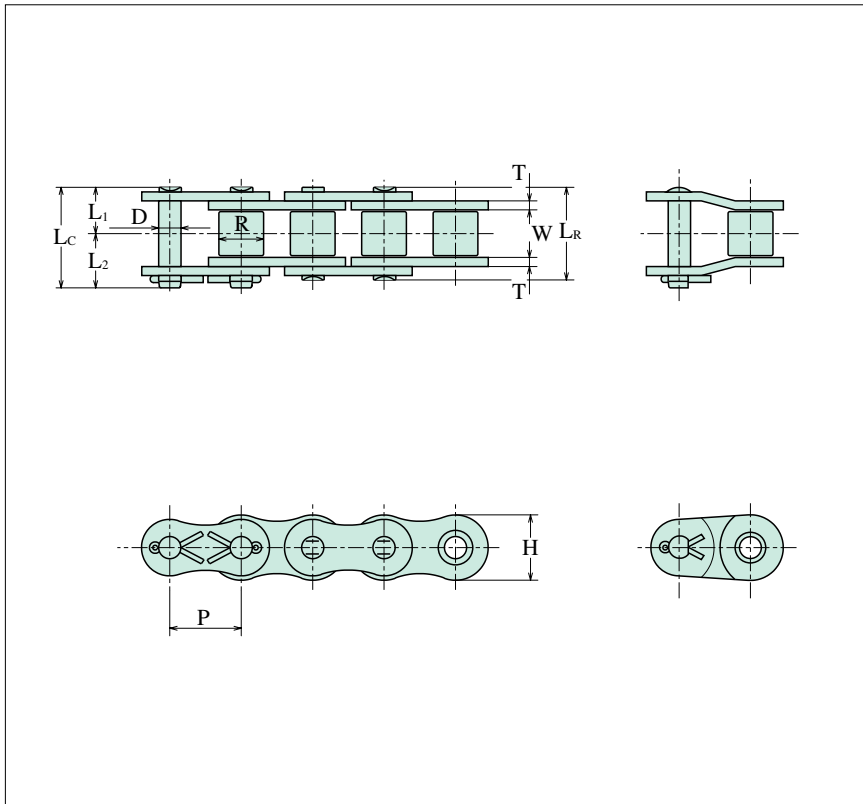

HE Series Roller Chains are manufactured with thicker side plates to insure greater capacity for absorbing shock loads. These are mainly used for applications where more stronger chains are needed, though space and design are limited.

Chain No.	Dimensions - mm										Average Ultimate Strength	Maximum Allowable Load	Average Chain Weight
	Pitch	Roller		Pin				Plate					
		Width	Dia.	Dia.	Length			Height	Thick.				
P	W	R	D	LR	LC	L1	L2	H	T	kN	kN	kg/m	
80HE	25.40	15.88	15.88	7.93	35.50	38.80	17.80	21.10	23.40	4.00	93.20	18.40	2.80
100HE	31.75	19.05	19.05	9.53	42.20	45.70	21.10	24.60	29.30	4.80	142.00	28.30	4.14
120HE	38.10	25.40	22.23	11.10	52.60	57.00	26.30	30.70	35.10	5.60	191.00	38.00	5.83
140HE	44.45	25.40	25.40	12.70	57.00	61.60	28.50	33.10	40.90	6.40	252.00	50.30	8.41
160HE	50.80	31.75	28.58	14.28	67.70	72.90	33.90	39.10	46.70	7.20	319.00	66.30	10.86
180HE	57.15	35.70	35.70	17.45	75.70	81.30	37.90	43.50	52.50	8.00	441.00	70.60	15.18
200HE	63.50	38.10	39.67	19.83	84.90	93.30	42.50	50.80	59.80	9.50	559.00	82.30	17.85

Note: ※ Standard sprockets can only be used with single Strand type

Straight Sidebar Chains

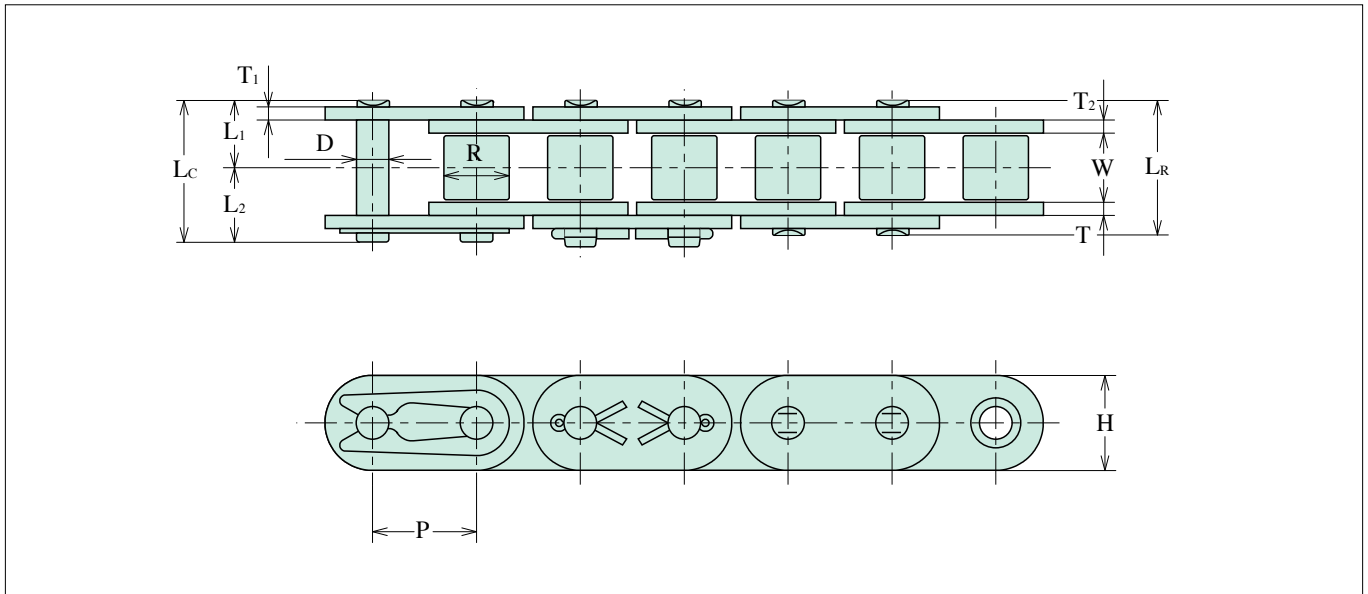

ANSI

Chain No.	Dimensions - mm										Average Ultimate Strength	Maximum Allowable Load	Average Chain Weight	Type of Conn Link
	Pitch	Roller		Pin				Plate						
		Width	Dia.	Dia.	Length			Height	Thick.					
P	W	R	D	LR	LC	L1	L2	H	T	kN	kN	kg/m		
35F	9.525	4.78	5.08	3.58	12.00	12.90	6.00	6.90	9.00	1.25	10.80	2.23	0.38	Spcl
40F	12.70	7.95	7.92	3.96	16.50	17.70	8.30	9.40	11.70	1.50	19.10	4.17	0.67	
50F	15.875	9.53	10.16	5.08	20.40	21.90	10.20	11.70	14.60	2.00	31.90	7.22	1.10	
60F	19.05	12.70	11.91	5.95	25.50	26.90	12.80	14.10	17.50	2.40	43.10	10.70	1.63	
80F	25.40	15.88	15.88	7.93	32.80	35.00	16.40	18.60	23.40	3.20	78.50	18.40	2.82	
100F	31.75	19.05	19.05	9.53	39.40	43.00	19.70	23.30	29.30	4.00	118.00	28.30	4.37	C
120F	38.10	25.40	22.23	11.10	49.50	53.40	24.80	28.60	35.10	4.80	167.00	38.00	6.45	
140F	44.45	25.40	25.40	12.70	54.00	58.30	27.00	31.30	40.90	5.60	216.00	50.30	8.29	
160F	50.80	31.75	28.58	14.28	64.30	68.70	32.20	36.50	46.70	6.40	275.00	66.30	10.96	
200F	63.50	38.10	39.67	19.83	78.50	87.00	39.30	47.70	59.80	8.00	451.00	82.30	18.96	
240F	76.20	47.63	47.63	23.78	96.40	104.10	48.20	55.90	70.30	9.50	677.00	112.80	26.47	

BS

Chain No.	Dimensions - mm											Minimum Ultimate Strength	Maximum Allowable Load	Average Chain Weight	Type of Conn Link
	Pitch	Roller		Pin				Plate							
		Width	Dia.	Dia.	Length			Height	Thickness						
P	W	R	D	LR	LC	L1	L2	H	T1	T2	kN	kN	kg/m		
06B-F	9.525	5.72	6.35	3.28	12.60	13.40	6.30	7.10	8.20	1.00	1.25	8.92	1.77	0.48	Spcl
08B-F	12.70	7.75	8.51	4.45	16.70	18.00	8.40	9.60	11.80	1.50		17.80	3.14	0.68	
10B-F	15.875	9.65	10.16	5.08	19.00	20.70	9.50	11.20	14.70	1.65		22.30	4.90	0.99	
12B-F	19.05	11.68	12.07	5.72	22.00	23.60	11.00	12.60	16.10	1.80		28.90	7.06	1.27	
16B-F	25.40	17.02	15.88	8.26	35.10	38.20	17.60	20.50	20.30	3.20	4.00	60.80	12.60	2.90	C
20B-F	31.75	19.56	19.05	10.16	40.20	44.00	20.10	23.90	26.00	3.50	4.50	95.10	19.60	4.21	
24B-F	38.10	25.40	25.40	14.63	53.40	58.10	26.70	31.40	33.40	4.80	5.90	161.00	27.50	8.16	
28B-F	44.45	30.99	27.94	15.88	65.10	70.50	32.60	37.90	36.60	6.30	7.40	201.00	34.30	10.37	
32B-F	50.80	30.99	29.21	17.81	65.00	71.10	32.50	38.60	41.70	6.30	6.90	250.00	39.20	11.11	

※Type of Conn Link is referred to page 8.

Super Roller Chains

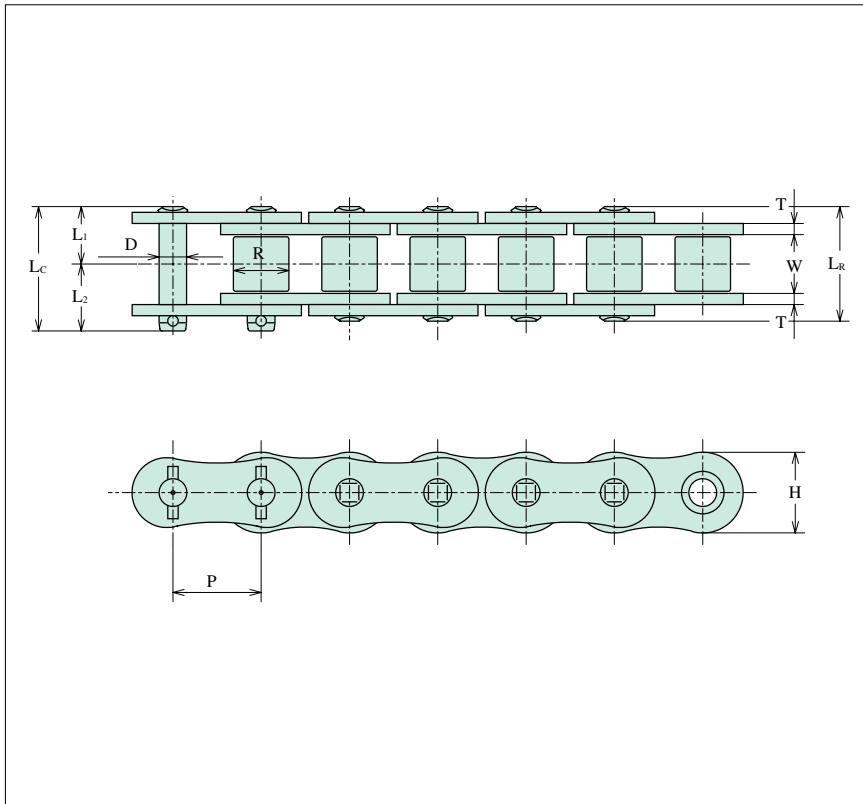

Super Roller Chains are upgraded to a high degree over existing ANSI standard roller chains. Big improvement has been made in particular with impact absorbing capacity.

Super Heavy Roller Chains provided with link plates of next larger chain size promise you higher performance and superior quality.

SINGLE STRANDS

Chain No. (ANSI)	Dimensions - mm										Average Ultimate Strength	Maximum Allowable Load	Average Chain Weight
	Pitch	Roller		Pin				Plate					
		Width	Dia.	Dia.	Length			Height	Thick.				
P	W	R	D	LR	LC	L1	L2	H	T	kN	kN	kg/m	
SUPER 80	25.40	15.88	15.88	7.93	32.60	35.50	16.30	19.20	24.10	3.20	84.30	18.60	2.81
SUPER 100	31.75	19.05	19.05	9.53	39.80	43.20	19.90	23.30	30.10	4.00	127.00	30.40	4.26
SUPER 120	38.10	25.40	22.23	11.10	49.70	53.70	24.90	28.80	36.20	4.80	186.00	39.20	6.30
SUPER 140	44.45	25.40	25.40	12.70	54.00	58.30	27.00	31.30	42.20	5.60	245.00	53.90	8.04
SUPER 160	50.80	31.75	28.58	14.28	64.40	69.00	32.20	36.80	48.20	6.40	314.00	70.60	10.80
SUPER 200	63.50	38.10	39.68	19.84	78.60	86.20	39.30	46.90	60.30	8.00	490.00	94.10	17.60
SUPER 240	76.20	47.63	47.63	23.80	96.40	103.40	48.20	55.20	72.40	9.50	726.00	132.00	25.60
SUPER 80H	25.40	15.88	15.88	7.93	35.90	38.90	18.00	20.90	24.10	4.00	98.10	20.60	3.33
SUPER 100H	31.75	19.05	19.05	9.53	42.60	46.20	21.30	24.90	30.10	4.80	145.00	32.40	4.88
SUPER 120H	38.10	25.40	22.23	11.10	52.80	57.30	26.90	30.40	36.20	5.60	196.00	42.20	6.94
SUPER 140H	44.45	25.40	25.40	12.70	57.20	61.90	28.60	33.30	42.20	6.40	255.00	56.90	8.87
SUPER 160H	50.80	31.75	28.58	14.28	67.90	72.80	34.00	38.80	48.20	7.10	324.00	73.50	11.70

- Note: ※ 1. Offset links are not available.
 2. Riveted type chain will be provided unless otherwise specified.
 Cottered type chain will be provided upon request.
 3. Press-fitted type connecting links will be supplied.

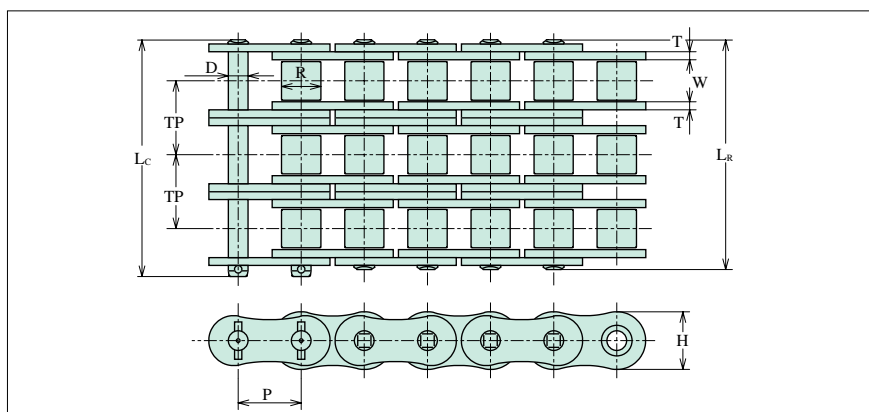

MULTIPLE STRANDS

Chain No.	Dimensions - mm											Average Ultimate Strength kN	Maximum Allowable Load kN	Average Chain Weight kg/m
	Pitch P	Roller		Pin				Plate		Trans. Pitch TP				
		Width W	Dia. R	Dia. D	Length		Height H	Thick. T						
					LR	LC	L1	L2						
SUPER80-2					62.00	64.90	31.00	33.90				169.00	31.60	5.63
SUPER80-3	25.40	15.88	15.88	7.93	91.30	94.20	45.70	48.50	24.10	3.20	29.30	253.00	46.50	8.41
SUPER80-4					120.60	123.50	60.30	63.20				337.00	61.40	11.18
SUPER100-2					75.40	79.00	37.70	41.30				255.00	51.60	8.38
SUPER100-3	31.75	19.05	19.05	9.53	111.20	114.80	55.60	59.20	30.10	4.00	35.80	381.00	76.00	12.57
SUPER100-4					147.00	150.60	73.50	77.10				508.00	100.00	16.77
SUPER120-2					95.40	99.40	47.70	51.70				372.00	66.60	12.44
SUPER120-3	38.10	25.40	22.23	11.10	140.80	144.80	70.40	74.40	36.20	4.80	45.40	558.00	98.00	18.65
SUPER120-4					186.20	190.20	93.10	97.10				744.00	129.00	24.85
SUPER140-2					103.30	107.60	51.70	55.90				490.00	91.60	15.92
SUPER140-3	44.45	25.40	25.40	12.70	152.20	156.50	76.10	80.40	42.20	5.60	48.90	735.00	134.00	23.84
SUPER140-4					201.10	205.40	100.60	104.80				980.00	177.00	32.10
SUPER160-2					123.20	127.80	61.60	66.20				628.00	120.00	21.44
SUPER160-3	50.80	31.75	28.58	14.28	181.70	186.30	90.90	95.40	48.20	6.40	58.50	942.00	176.00	32.10
SUPER160-4					240.20	244.80	120.10	124.70				1256.00	233.00	42.84
SUPER200-2					150.60	158.20	75.30	82.90				980.00	160.00	34.91
SUPER200-3	63.50	38.10	39.67	19.83	222.20	229.80	111.10	118.70	60.30	8.00	71.60	1470.00	235.00	52.44
SUPER200-4					293.80	301.40	146.90	154.50				1960.00	310.00	69.74
SUPER240-2					184.20	191.20	92.10	99.10				1452.00	224.00	50.88
SUPER240-3	76.20	47.63	47.63	23.78	272.00	279.00	136.00	143.00	72.40	9.50	87.80	2178.00	330.00	76.12
SUPER240-4					359.80	366.80	179.90	186.90				2904.00	436.00	101.40
SUPER 80H-2	25.40	15.88	15.88	7.93	68.60	71.60	34.30	37.30	24.10	4.00	32.60	196.20	35.02	6.67
SUPER 80H-3					101.20	104.20	50.60	53.60				294.30	51.50	9.96
SUPER 100H-2	31.75	19.05	19.05	9.53	81.60	85.40	40.80	44.60	30.10	4.80	39.10	290.00	55.08	9.60
SUPER 100H-3					120.70	124.50	60.40	64.10				435.00	81.00	14.40
SUPER 120H-2	38.10	25.40	22.23	11.10	102.00	106.40	51.00	55.40	36.20	5.60	48.90	392.00	71.74	13.71
SUPER 120H-3					150.90	155.40	75.50	79.90				588.00	105.50	20.55
SUPER 140H-2	44.45	25.40	25.40	12.70	109.60	114.20	54.80	59.40	42.20	6.40	52.20	510.00	96.73	17.56
SHPER 140H-3					161.80	166.50	80.90	85.60				765.00	142.25	26.30
SUPER 160H-2	50.80	31.75	28.58	14.28	130.00	134.80	65.00	69.80	48.20	7.10	61.90	648.00	124.95	23.15
SUPER 160H-3					192.00	196.80	96.00	100.80				972.00	183.75	34.67

SUPER ROLLER CHAIN

KILOWATT RATING OF SUPER 80

No. of Teeth Small Spkt.	Revolutions per Minute (RPM)-Small Sprocket													
	10	25	50	100	200	300	400	500	600	700	800	900	1000	
	Lubrication Method B						C			D				
13	0.87	1.98	3.70	6.91	12.89	18.57	24.05	29.40	34.64	32.10	26.27	22.02	18.80	
14	0.94	2.15	4.01	7.48	13.96	20.11	26.06	31.85	37.53	35.87	29.36	24.60	21.01	
15	1.01	2.32	4.32	8.06	15.04	21.67	28.07	34.31	40.43	39.78	32.56	27.29	23.30	
16	1.09	2.48	4.63	8.64	16.13	23.23	30.10	36.79	43.35	43.82	35.87	30.06	25.67	
17	1.16	2.65	4.95	9.23	17.22	24.80	32.13	39.28	46.29	48.00	39.28	32.92	28.11	
18	1.24	2.82	5.26	9.82	18.32	26.38	34.18	41.78	49.23	52.29	42.80	35.87	30.63	
19	1.31	2.99	5.58	10.41	19.42	27.97	36.24	44.30	52.19	56.71	46.42	38.90	33.21	
20	1.38	3.16	5.89	11.00	20.52	29.56	38.30	46.82	55.17	61.25	50.13	42.01	35.87	
21	1.46	3.33	6.21	11.59	21.63	31.16	40.37	49.35	58.15	65.90	53.94	45.20	38.59	
22	1.53	3.50	6.53	12.19	22.75	32.77	42.45	51.89	61.15	70.25	57.83	48.47	41.38	
24	1.69	3.85	7.18	13.39	24.99	36.00	46.64	57.01	67.17	77.17	65.90	55.23	47.15	
26	1.84	4.19	7.82	14.60	27.25	39.25	50.85	62.15	73.24	84.14	74.30	62.27	53.17	
30	2.15	4.89	9.13	17.04	31.80	45.81	59.34	72.54	85.48	98.20	92.09	77.18	65.90	
32	2.30	5.25	9.79	18.27	34.10	49.11	63.63	77.78	91.65	105.29	101.46	85.03	72.60	
35	2.53	5.78	10.79	20.13	37.56	54.10	70.09	85.68	100.96	115.99	116.05	97.26	83.04	
40	2.93	6.68	12.46	23.25	43.39	62.50	80.97	98.98	116.62	133.98	141.79	118.83	101.46	

KILOWATT RATING OF SUPER 100

No. of Teeth Small Spkt.	Revolutions per Minute (RPM)-Small Sprocket												
	10	25	50	100	200	300	400	500	600	700	800	900	1000
	Lubrication Method B				C				D				
13	1.47	3.35	6.25	11.66	21.76	31.35	40.61	49.65	48.35	38.37	31.40	26.32	22.47
14	1.59	3.63	6.77	12.64	23.58	33.96	44.00	53.78	54.04	42.88	35.10	29.41	25.11
15	1.71	3.91	7.29	13.61	25.40	36.59	47.40	57.94	59.93	47.56	38.92	32.62	27.85
16	1.84	4.19	7.82	14.60	27.24	39.23	50.82	62.13	66.02	52.39	42.88	35.94	30.68
17	1.96	4.48	8.35	15.58	29.08	41.88	54.26	66.33	72.30	57.38	46.96	39.36	33.60
18	2.09	4.76	8.88	16.58	30.93	44.55	57.72	70.56	78.78	62.51	51.17	42.88	36.61
19	2.21	5.05	9.42	17.57	32.79	47.23	61.19	74.80	85.43	67.80	55.49	46.50	39.71
20	2.34	5.33	9.95	18.57	34.66	49.92	64.67	79.06	92.26	73.22	59.93	50.22	42.88
21	2.46	5.62	10.49	19.58	36.52	52.62	68.17	83.34	98.20	78.78	64.48	54.04	46.11
22	2.59	5.91	11.03	20.59	38.42	55.33	71.69	87.63	103.26	84.47	69.14	57.94	49.47
24	2.85	6.49	12.12	22.61	42.20	60.79	78.75	96.26	113.43	96.25	78.78	66.02	56.37
26	3.10	7.08	13.21	24.66	46.01	66.27	85.86	104.96	123.67	108.52	88.83	74.44	63.56
30	3.62	8.26	15.42	28.78	53.70	77.35	100.21	122.50	144.34	134.51	110.09	92.26	78.78
32	3.88	8.86	16.53	30.86	57.58	82.93	107.41	131.34	154.76	148.18	121.28	101.64	86.78
35	4.28	9.76	18.22	33.99	63.43	91.36	118.36	144.69	170.49	169.50	138.73	116.27	99.27
40	4.94	11.28	21.04	39.26	73.27	105.54	136.72	167.13	196.94	207.09	169.50	142.05	121.28

KILOWATT RATING OF SUPER 120

No. of Teeth Small Spkt.	Revolutions per Minute (RPM)-Small Sprocket												
	10	25	50	100	200	300	400	500	600	700	800	900	1000
	Lubrication Method B				C				D				
13	2.27	5.18	9.67	18.05	33.68	48.51	62.84	73.54	55.94	44.39	36.34	30.45	26.00
14	2.46	5.61	10.48	19.55	36.48	52.55	68.08	82.19	62.52	49.61	40.61	34.03	29.06
15	2.65	6.05	11.29	21.06	39.30	56.61	73.34	89.65	69.34	55.02	45.04	37.74	32.23
16	2.84	6.49	12.10	22.58	42.14	60.70	78.64	96.13	76.39	60.62	49.61	41.58	35.50
17	3.04	6.92	12.92	24.11	44.99	64.81	83.96	102.63	83.66	66.39	54.34	45.54	38.88
18	3.23	7.36	13.74	25.65	47.86	68.93	89.30	109.17	91.15	72.33	59.20	49.61	42.36
19	3.42	7.81	14.57	27.19	50.73	73.08	94.67	115.73	98.85	78.44	64.20	53.81	45.94
20	3.62	8.25	15.40	28.74	53.62	77.24	100.07	122.32	106.75	84.71	69.34	58.11	49.61
21	3.81	8.70	16.23	30.29	56.53	81.42	105.48	128.94	114.86	91.15	74.60	62.52	53.38
22	4.01	9.15	17.07	31.85	59.44	85.61	110.92	135.58	123.16	97.73	79.99	67.04	57.24
24	4.41	10.05	18.75	34.99	65.29	94.05	121.84	148.94	140.33	111.36	91.15	76.39	65.22
26	4.80	10.96	20.44	38.15	71.19	102.54	132.85	162.39	158.23	125.57	102.77	86.13	73.54
30	5.61	12.79	23.86	44.53	83.09	119.68	155.05	189.53	196.12	155.63	127.38	106.75	91.15
32	6.01	13.71	25.58	47.74	89.09	128.32	166.24	203.22	216.05	171.45	140.33	117.60	100.41
35	6.62	15.10	28.18	52.59	98.14	141.36	183.13	223.87	247.14	196.12	160.52	134.52	114.86
40	7.65	17.45	32.56	60.75	113.36	163.29	211.54	258.59	301.94	239.61	196.12	164.36	140.33

KILOWATT RATING OF SUPER 140

No. of Teeth Small Spkt.	Revolutions per Minute (RPM)-Small Sprocket												
	10	25	50	100	200	300	400	500	600	700	800	900	1000
	Lubrication Method B				C				D				
13	3.30	7.52	14.03	26.18	48.86	70.37	91.17	83.19	63.29	50.22	41.11	34.45	29.41
14	3.57	8.14	15.20	28.36	52.93	76.23	98.76	92.97	70.73	56.13	45.94	38.50	32.87
15	3.85	8.78	16.37	30.56	57.02	82.13	106.40	103.11	78.44	62.25	50.95	42.70	36.45
16	4.12	9.41	17.56	32.76	61.14	88.06	114.09	113.59	86.41	68.57	56.13	47.04	40.16
17	4.40	10.05	18.74	34.98	65.27	94.02	121.80	124.40	94.64	75.10	61.47	51.51	43.98
18	4.68	10.68	19.94	37.21	69.43	100.01	129.56	135.54	103.11	81.82	66.97	56.13	47.92
19	4.97	11.33	21.14	39.44	73.60	106.02	137.35	146.99	111.82	88.74	72.63	60.87	51.97
20	5.25	11.97	22.34	41.69	77.80	112.06	145.18	158.75	120.76	95.83	78.44	65.74	56.13
21	5.53	12.62	23.55	43.95	82.01	118.12	153.03	170.80	129.93	103.11	84.39	70.73	60.39
22	5.82	13.27	24.76	46.21	86.23	124.21	160.91	183.15	139.32	110.56	90.49	75.84	64.75
24	6.39	14.58	27.20	50.76	94.73	136.45	176.77	208.68	158.75	125.98	103.11	86.41	73.78
26	6.97	15.89	29.66	55.35	103.28	148.77	192.73	235.30	179.00	142.05	116.26	97.43	83.19
30	8.13	18.55	34.62	64.60	120.54	173.63	224.94	274.97	221.86	176.06	144.10	120.76	103.11
32	8.72	19.89	37.12	69.26	129.25	186.16	241.18	294.82	244.41	193.95	158.75	133.04	113.59
35	9.61	21.91	40.89	76.30	142.38	205.08	265.69	324.78	279.57	221.86	181.59	152.18	129.93
40	11.10	25.31	47.23	88.14	164.47	236.90	306.91	375.17	341.57	271.06	221.86	185.93	158.75

KILOWATT RATING OF SUPER 160

No. of Teeth Small Spkt.	Revolutions per Minute (RPM)-Small Sprocket												
	10	25	50	100	200	300	400	500	600	700	800	900	1000
	B						C			D			
13	4.58	10.44	19.48	36.34	67.82	97.69	126.56	92.57	70.42	55.88	45.74	38.33	32.73
14	4.96	11.31	21.10	39.37	73.47	105.83	137.11	103.45	78.70	62.45	51.12	42.84	36.58
15	5.34	12.18	22.73	42.42	79.16	114.02	147.71	114.73	87.28	69.26	56.69	47.51	40.56
16	5.73	13.06	24.37	45.48	84.87	122.25	158.37	126.40	96.15	76.30	62.45	52.34	44.69
17	6.11	13.94	26.02	48.56	90.61	130.52	169.09	138.43	105.31	83.57	68.40	57.32	48.94
18	6.50	14.83	27.68	51.65	96.38	138.83	179.86	150.82	114.73	91.05	74.52	62.45	53.32
19	6.89	15.72	29.34	54.76	102.18	147.18	190.67	163.56	124.43	98.74	80.82	67.73	57.83
20	7.29	16.62	31.01	57.88	108.00	155.56	201.53	176.65	134.38	106.64	87.28	73.15	62.45
21	7.68	17.52	32.69	61.01	113.84	163.98	212.44	190.06	144.58	114.73	93.91	78.70	67.20
22	8.08	18.42	34.38	64.15	119.71	172.43	223.38	203.79	155.03	123.03	100.70	84.39	72.05
24	8.87	20.24	37.76	70.47	131.50	189.42	245.39	232.21	176.65	140.18	114.73	96.15	82.10
26	9.67	22.06	41.17	76.83	143.38	206.52	267.55	261.83	199.18	158.06	129.37	108.42	92.57
30	11.29	25.75	48.06	89.68	167.34	241.04	312.27	324.52	246.87	195.91	160.35	134.38	114.73
32	12.10	27.61	51.52	96.15	179.42	258.44	334.81	357.50	271.96	215.82	176.65	148.04	126.40
35	13.33	30.42	56.76	105.92	197.65	284.70	368.83	408.94	311.09	246.87	202.06	169.34	144.58
40	15.40	35.14	65.57	122.35	228.31	328.86	426.05	499.63	380.08	301.62	246.87	206.89	0.00

KILOWATT RATING OF SUPER 200

No. of Teeth Small Spkt.	Revolutions per Minute (RPM)-Small Sprocket										
	5	10	20	30	40	50	60	80	100	150	200
	B		C				D				
13	5.22	9.73	18.16	26.16	33.89	41.43	48.81	63.24	77.30	111.35	144.26
14	5.65	10.54	19.67	28.34	36.71	44.88	52.88	68.51	83.75	120.63	156.28
15	6.09	11.36	21.20	30.53	39.55	48.35	56.97	73.81	90.23	129.96	168.37
16	6.53	12.18	22.73	32.73	42.41	51.84	61.08	79.14	96.74	139.34	180.52
17	6.97	13.00	24.26	34.95	45.28	55.35	65.22	84.49	103.28	148.77	192.73
18	7.41	13.83	25.81	37.18	48.16	58.87	69.37	89.87	109.86	158.24	205.01
19	7.86	14.66	27.36	39.41	51.06	62.41	73.54	95.28	116.47	167.76	217.33
20	8.30	15.50	28.92	41.66	53.97	65.97	77.73	100.70	123.10	177.31	229.71
21	8.75	16.34	30.48	43.91	56.89	69.54	81.94	106.15	129.76	186.91	242.14
22	9.21	17.18	32.05	46.17	59.82	73.12	86.16	111.62	136.45	196.54	254.62
24	10.11	18.87	35.21	50.72	65.71	80.32	94.65	122.62	149.89	215.90	279.71
26	11.03	20.57	38.39	55.30	71.64	87.58	103.19	133.69	163.43	235.40	304.96
30	12.87	24.01	44.81	64.54	83.62	102.21	120.44	156.03	190.74	274.74	355.93
32	13.80	25.75	48.04	69.20	89.65	109.59	129.14	167.30	204.51	294.57	381.63
35	15.20	28.36	52.93	76.23	98.76	120.73	142.26	184.30	225.29	324.51	420.41
40	17.56	32.76	61.14	88.06	114.08	139.46	164.33	212.89	260.24	374.85	485.62

KILOWATT RATING OF SUPER 240

No. of Teeth Small Spkt.	Revolutions per Minute (RPM)-Small Sprocket												
	5	10	15	20	25	30	40	50	60	80	100	125	150
	B		C				D						
13	8.03	14.99	21.59	27.97	34.19	40.28	52.19	63.79	75.17	97.38	119.04	145.52	171.47
14	8.70	16.24	23.38	30.30	37.03	43.64	56.53	69.11	81.43	105.50	128.96	157.64	185.75
15	9.37	17.49	25.19	32.64	39.90	47.01	60.91	74.45	87.73	113.66	138.94	169.84	200.12
16	10.05	18.75	27.01	35.00	42.78	50.41	65.30	79.83	94.06	121.86	148.97	182.10	214.57
17	10.73	20.02	28.84	37.36	45.67	53.82	69.72	85.23	100.43	130.11	159.04	194.42	229.09
18	11.41	21.30	30.68	39.74	48.58	57.25	74.16	90.66	106.82	138.39	169.17	206.80	243.68
19	12.10	22.58	32.52	42.13	51.50	60.69	78.62	96.11	113.25	146.71	179.34	219.23	258.33
20	12.79	23.86	34.37	44.53	54.44	64.14	83.10	101.58	119.70	155.07	189.56	231.72	273.04
21	13.48	25.16	36.23	46.94	57.38	67.61	87.60	107.08	126.17	163.46	199.82	244.26	287.82
22	14.18	26.45	38.10	49.36	60.34	71.10	92.11	112.60	132.67	171.88	210.11	256.84	302.64
24	15.57	29.06	41.85	54.22	66.28	78.10	101.19	123.69	145.75	188.82	230.81	282.15	332.46
26	16.98	31.68	45.63	59.12	72.27	85.16	110.32	134.86	158.91	205.87	251.66	307.63	362.48
30	19.82	36.98	53.26	69.00	84.35	99.39	128.76	157.40	185.46	240.27	293.71	359.04	423.07
32	21.25	39.65	57.11	73.98	90.44	106.56	138.05	168.76	198.85	257.62	314.92	384.96	453.61
35	23.40	43.67	62.91	81.50	99.63	117.39	152.08	185.91	219.06	283.80	346.92	424.08	499.70
40	27.04	50.45	72.67	94.14	115.08	135.60	175.68	214.75	253.04	327.82	400.74	489.87	577.22

Note: Lubricated types A, B, C and D on the table are shown on page 70.
: Whenever possible, selection should not be made from the colored sections of the table.

ROLLER CHAINS
DOUBLE PITCH ROLLER CHAINS
HOLLOW PIN CHAINS
CORROSION RESISTANT ROLLER CHAINS
LEAF CHAINS
ATTACHMENT CHAINS
TECHNICAL INFORMATION

Double Capacity Chains

Double Capacity chain consists of twice the number of side plates as single strand chain, therefore its working load is close to standard double strand chain.

Double Capacity chain operate on standard single strand sprocket.

Multiple strand Double Capacity chains are not available.

Chain speed should be less than 50 m /min.

DC (x2)

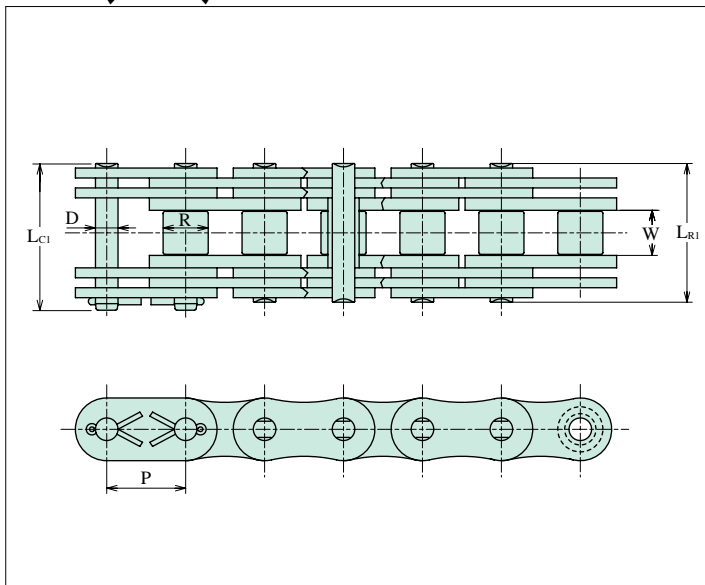

TC (x3)

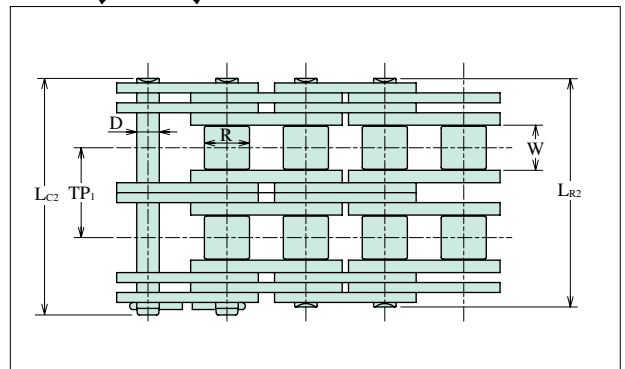

FC (x4)

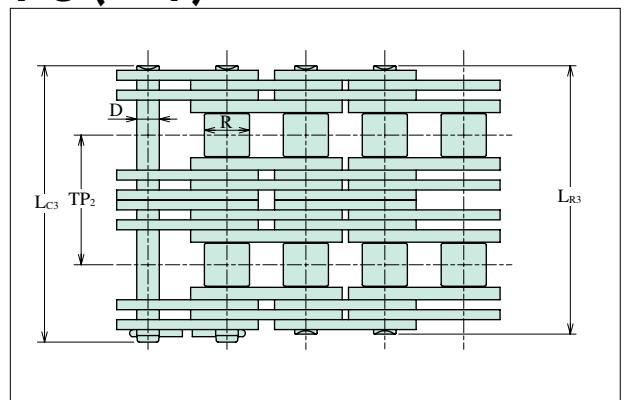

$$LR2 = LR1 + TP1$$

$$LC2 = LC1 + TP1$$

$$LR3 = LR1 + TP2$$

$$LC3 = LC1 + TP2$$

ANSI

Chain No.	Dimensions - mm								Average Ultimate Strength (kN)			Maximum Allowable Load (kN)
	Pitch	Roller		Pin		Transverse Pitch		DC	TC	FC		
		Width	Dia.	Dia.	Length	TP1	TP2					
P	W	R	D	LR1	LC1	TP1	TP2	DC	TC	FC	DC	
80 DC·TC·FC	25.40	15.88	15.88	7.93	45.60	48.70	29.30	42.10	149	223	298	22.40
100 DC·TC·FC	31.75	19.05	19.05	9.53	55.80	59.50	35.80	51.80	224	336	448	33.50
120 DC·TC·FC	38.10	25.40	22.23	11.10	69.00	73.30	45.40	64.20	317	475	634	49.00
140 DC·TC·FC	44.45	25.40	25.40	12.70	76.40	81.10	48.90	71.30	410	615	820	64.40
160 DC·TC·FC	50.80	31.75	28.58	14.28	90.00	95.10	58.50	84.10	522	783	1044	79.80
180 DC·TC·FC	57.15	35.70	35.70	17.45	101.60	107.70	65.80	94.60	670	1005	1340	103.00
200 DC·TC·FC	63.50	38.10	39.67	19.83	111.20	120.00	71.60	103.60	857	1285	1714	133.00
240 DC·TC·FC	76.20	47.63	47.63	23.78	135.60	143.20	87.80	125.80	1286	1929	2572	193.00

BS

Chain No.	Dimensions - mm								Average Ultimate Strength (kN)			Maximum Allowable Load (kN)
	Pitch	Roller		Pin			Transverse Pitch		DC	TC	FC	DC
		Width	Dia.	Dia.	Length		TP ₁	TP ₂				
P	W	R	D	LR ₁	LC ₁	TP ₁	TP ₂	DC	TC	FC	DC	
16BDC·TC·FC	25.40	17.02	15.88	8.26	50.00	53.20	31.90	44.70	130	195	260	19.50
20BDC·TC·FC	31.75	19.56	19.05	10.16	56.00	60.40	36.50	50.50	201	301	402	30.20
24BDC·TC·FC	38.10	25.40	25.40	14.63	75.40	80.50	48.40	68.00	340	510	680	51.20
28BDC·TC·FC	44.45	31.00	27.94	15.88	93.00	98.80	59.60	84.80	424	636	848	63.80
32BDC·TC·FC	50.80	31.00	29.21	17.81	92.40	98.50	58.60	83.80	520	780	1040	78.40

Double Capacity Double Pitch Chains

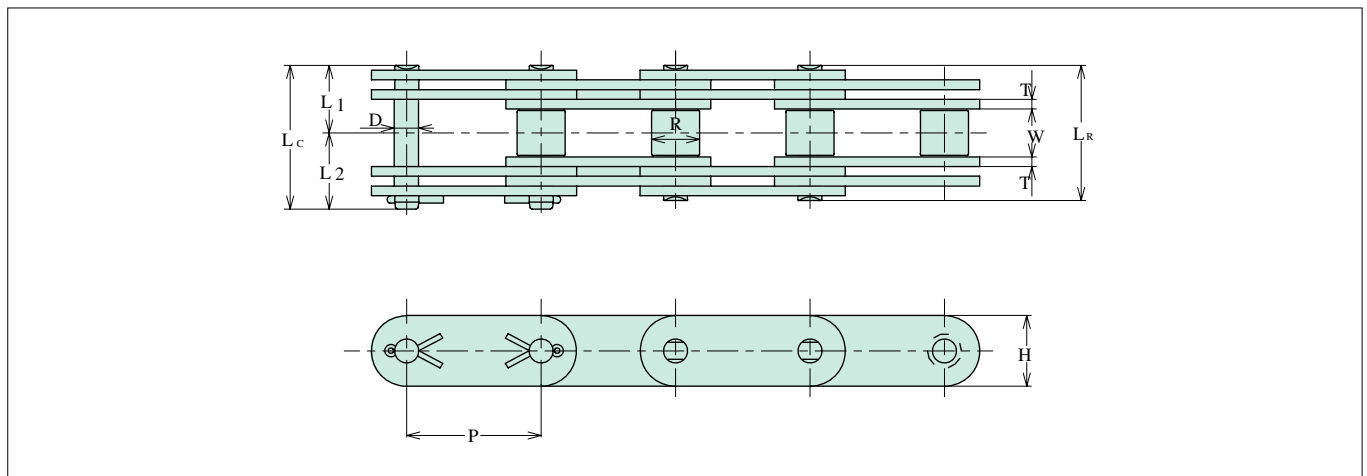

DOUBLE PITCH

Chain No.	Dimensions - mm										Average Ultimate Strength	Maximum Allowable Load	Average Chain Weight
	Pitch	Roller		Pin				Plate					
		Width	Dia.	Dia.	Length			Height	Thickness				
P	W	R	D	LR	LC	L1	L2	H	T	kN	kN	kg/m	
C2040 DC	25.40	7.95	7.92	3.96	23.00	24.70	11.50	13.20	11.40	1.50	38.20	4.02	0.50
C2050 DC	31.75	9.53	10.16	5.08	28.80	30.50	14.40	16.10	15.00	2.00	63.80	6.72	0.85
C2060H DC	38.10	12.70	11.91	5.95	42.20	44.20	21.10	23.10	17.00	3.20	109.80	11.56	1.46
C2080H DC	50.80	15.88	15.88	7.93	52.00	55.10	26.00	29.10	22.60	4.00	180.40	18.99	2.50
C2100H DC	63.50	19.05	19.05	9.53	62.00	65.60	31.00	34.60	28.60	4.80	274.00	28.84	3.81
C2120H DC	76.20	25.40	22.23	11.10	77.80	82.10	38.90	43.20	34.90	5.60	372.00	39.16	5.50
C2160H DC	101.60	31.75	28.58	14.28	97.40	102.60	48.70	53.90	47.60	7.20	612.00	64.42	9.27

Freedom Series Self-Lubricating Chains

Freedom Series Self-Lubricating Chains perform well in the application without additional lubrication.

Oil impregnated sintered steel bushing provides self-lubricating and it is ideal for the industries that cleanliness is critical such as packaging, printing, food processing, textile and so on.

Moreover it is designed for applications where regular maintenance is not easily accessible.

Fundamental Structure

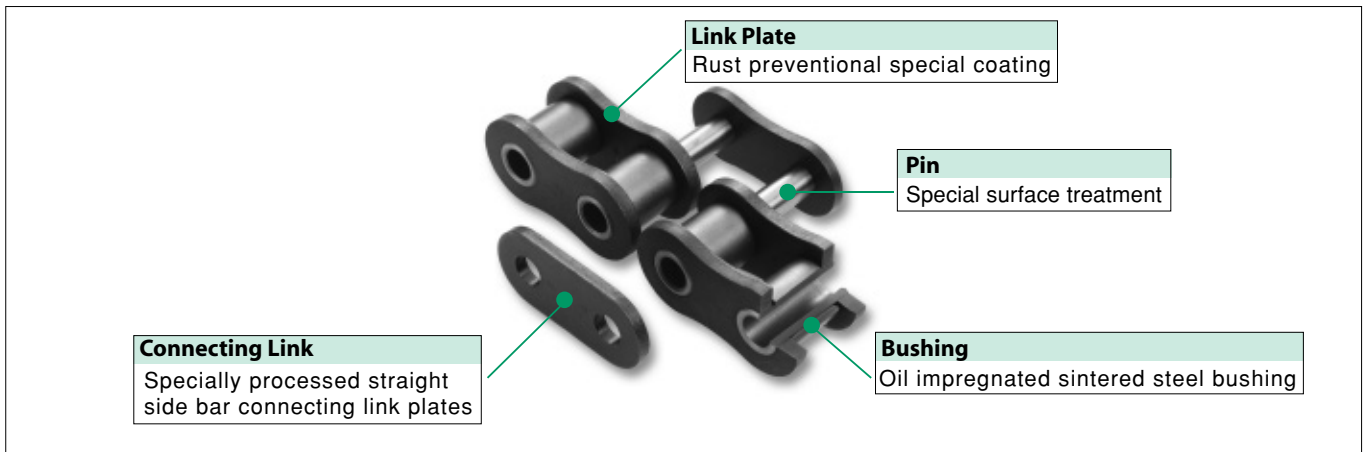

Wear Resistance

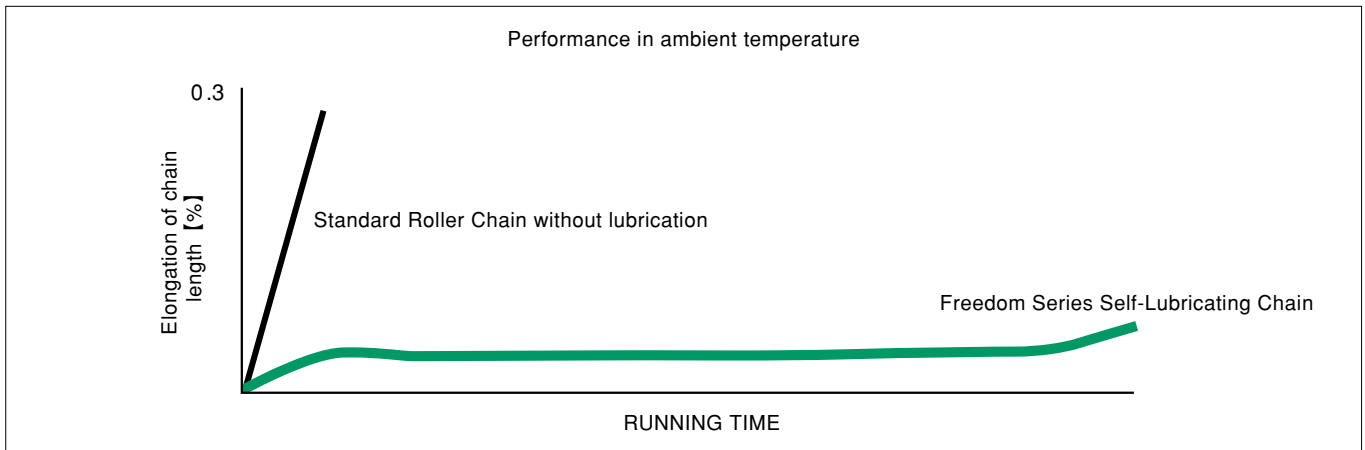

Caution and Selection

- 1) In dusty environments, dusts absorb the lubrication of sintered steel bushings and it causes premature wear.
- 2) Used in water, the chain wears quickly.
- 3) Range of speed is from slow speed 25m/min to high speed 75m/min.
- 4) When lubrication depletes in the sintered steel bushings, the chain wears abruptly.
- 5) Operating temperature is from -10°C to 150°C.
When ambient temperature is over 80°C, lubrication seeps out quickly.
- 6) The sintered bushings are heat treated, and allow standard chain selection.
- 7) An application of sintered steel bushing associated with shock load is not appropriate.

Freedom Series ANSI Self-Lubricating Chains

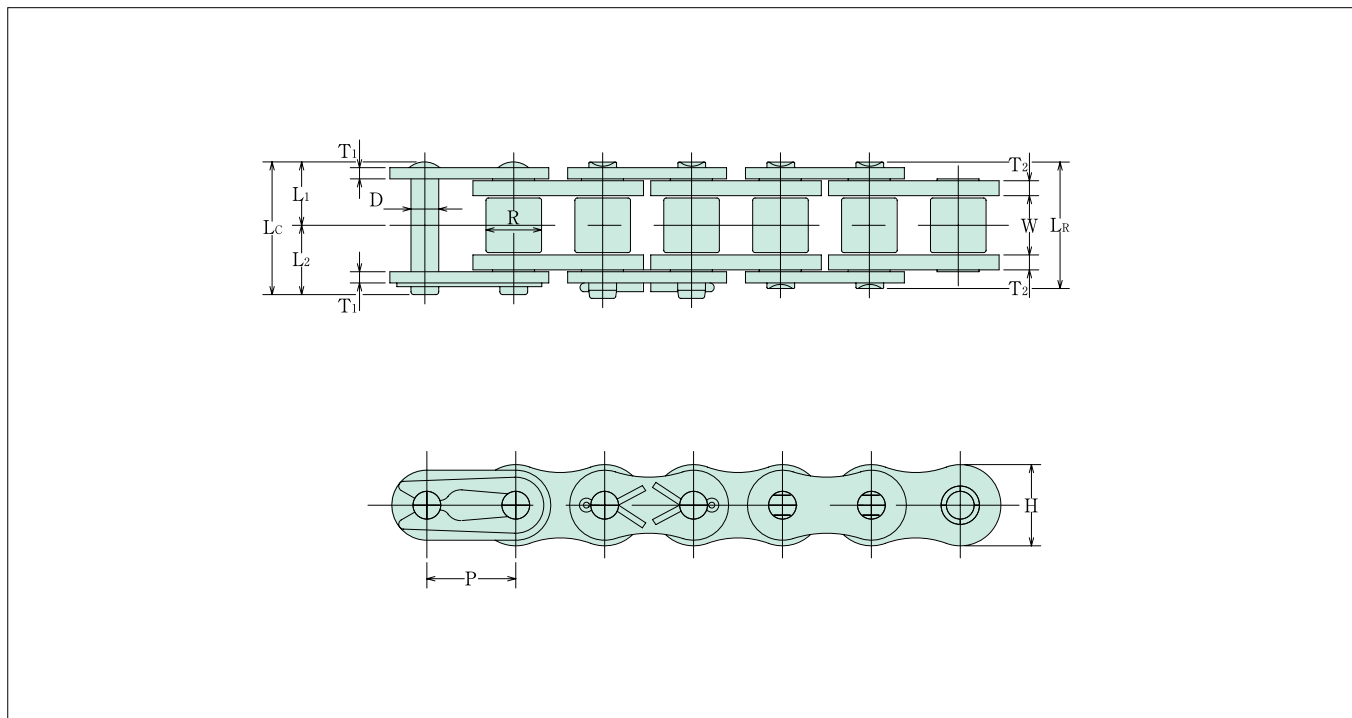

TS type (for Drive)

Chain No.	Dimensions - mm												Average Ultimate Strength	Maximum Allowable Load	Average Chain Weight
	Pitch	Roller		Pin				Plate		Trans. Pitch					
		Width	Dia.	Dia.	Length			Height	Thickness						
P	W	R	D	LR	LC	L1	L2	H	T1	T2	TP	kN	kN	kg/m	
40FS-TS	12.70	7.95	7.92	3.96	17.50	19.60	8.80	10.80	11.70	1.50	2.00	15.60	19.10	3.63	0.70
50FS-TS	15.875	9.53	10.16	5.08	21.30	23.30	10.70	12.60	14.60	2.00	2.40	19.20	31.90	6.28	1.10
60FS-TS	19.05	12.70	11.91	5.95	27.40	29.80	13.70	16.10	17.50	2.40	3.20	24.90	43.10	8.63	1.70
80FS-TS	25.40	15.88	15.88	7.93	34.10	37.40	17.10	20.30	23.40	3.20	4.00	31.10	78.50	14.70	2.70
100FS-TS	31.75	19.05	19.05	9.53	41.00	44.80	20.50	24.30	29.30	4.00	4.80	37.60	118.00	22.60	4.30

*Standard sprocket is available for single strand.

CS type (for Conveyor)

Chain No.	Dimensions - mm												Average Ultimate Strength	Maximum Allowable Load	Average Chain Weight
	Pitch	Roller		Pin				Plate		Trans. Pitch					
		Width	Dia.	Dia.	Length			Height	Thickness						
P	W	R	D	LR	LC	L1	L2	H	T	TP	kN	kN	kg/m		
40FS-CS	12.70	7.95	7.92	3.96	16.50	18.60	8.30	10.30	11.70	1.50	14.40	15.70	3.62	0.60	
50FS-CS	15.875	9.53	10.16	5.08	20.50	22.50	10.30	12.20	14.60	2.00	18.10	25.50	6.27	1.00	
60FS-CS	19.05	12.70	11.91	5.95	25.90	28.30	13.70	14.60	17.50	2.40	22.80	37.30	8.63	1.50	
80FS-CS	25.40	15.88	15.88	7.93	33.00	35.90	16.50	19.40	23.40	3.20	29.30	63.70	14.70	2.50	
100FS-CS	31.75	19.05	19.05	9.53	39.80	43.10	19.90	23.20	29.30	4.00	35.80	100.00	22.50	3.90	

*Standard sprocket is available for multiple strands.

*Attachment can be installed

Freedom Series BS Self-Lubricating Chains

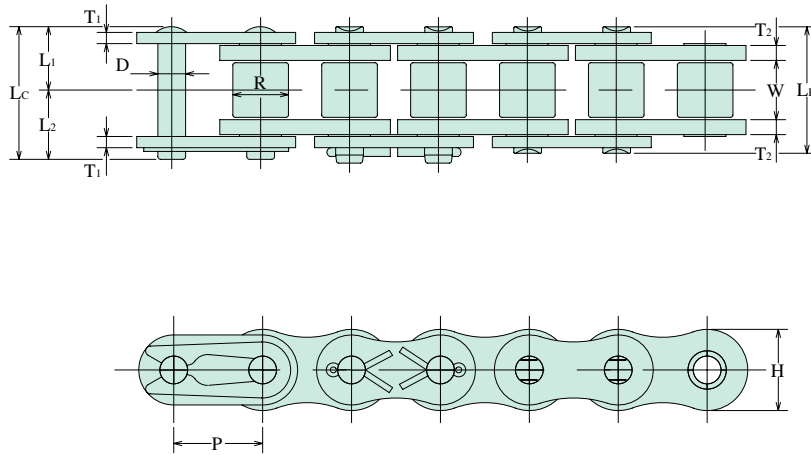

Chain No.	Dimensions - mm											Average Ultimate Strength	Maximum Allowable Load	Average Chain Weight
	Pitch	Roller		Pin					Plate					
		Width	Dia.	Dia.	Length				Height	Thickness				
		P	W	R	D	LR	LC	L1	L2	H	T1			
08B-FS	12.70	7.75	8.51	4.45	16.70	18.60	8.40	10.20	11.80	1.50	1.50	16.80	2.90	0.60
10B-FS	15.875	9.65	10.16	5.08	19.40	21.00	9.70	11.30	14.50	1.65	1.65	24.60	4.40	0.90
12B-FS	19.05	11.68	12.07	5.72	22.00	24.40	11.00	13.40	17.40	1.80	1.80	32.40	6.30	1.10
16B-FS	25.40	17.02	15.87	8.26	35.10	38.20	17.60	20.60	21.00	3.10	3.90	74.60	12.20	2.60
20B-FS	31.75	19.56	19.05	10.16	40.20	44.00	20.10	23.90	29.30	3.50	4.70	128.30	19.10	3.80
24B-FS	38.10	25.40	25.40	14.63	53.40	58.10	26.70	31.40	35.10	4.70	5.90	195.60	25.50	7.30
28B-FS	44.45	31.00	27.94	15.88	65.10	70.50	32.60	37.90	37.00	6.30	7.40	215.70	34.80	9.30
32B-FS	50.80	31.00	29.21	15.88	64.20	69.60	32.10	37.50	42.20	6.30	6.90	274.60	44.10	9.90

*Standard sprocket is available.

*Attachment can be installed.

Freedom Series Double Pitch Self-Lubricating Chains

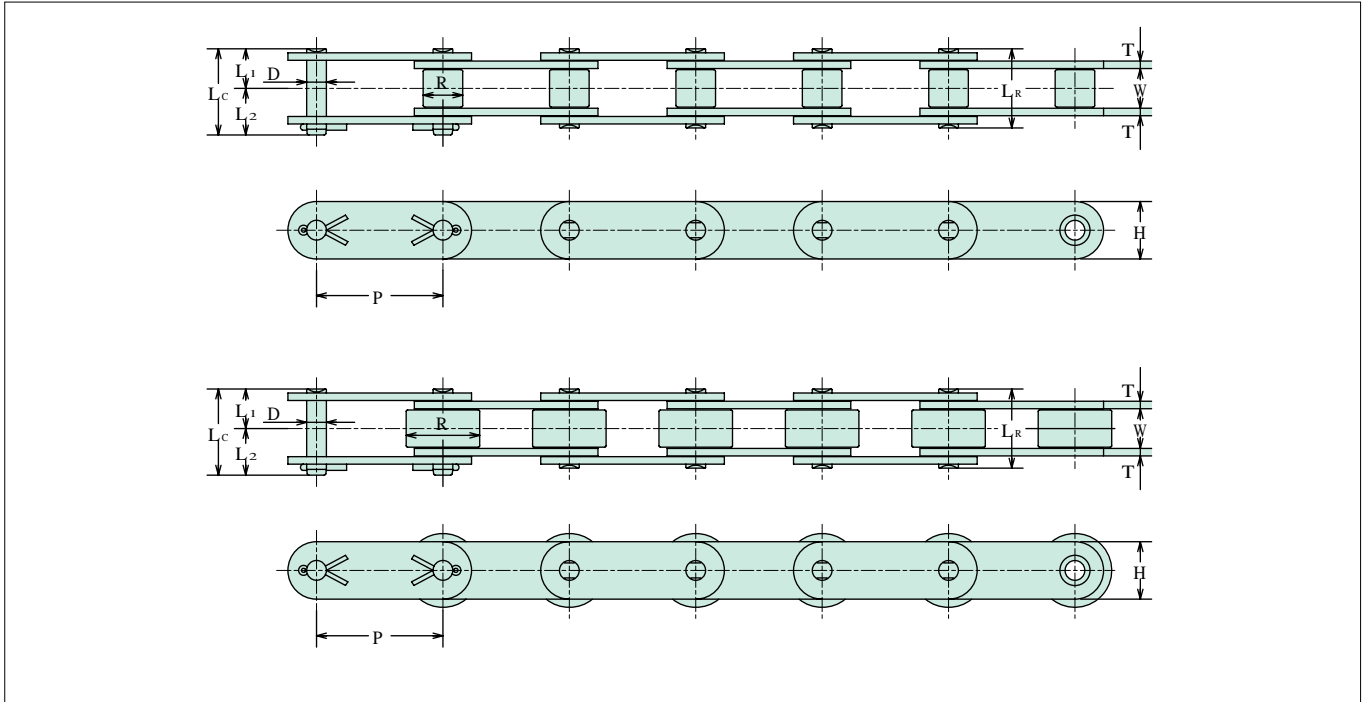

Small Roller

Chain No.	Dimensions - mm										Average Ultimate Strength kN	Maximum Allowable Load kN	Average Chain Weight kg/m
	Pitch	Roller		Pin				Plate					
		Width	Dia.	Dia.	Length			Height	Thick.				
	P	W	R	D	L _R	L _C	L ₁	L ₂	H	T			
C2040-FS	25.40	7.95	7.92	3.96	16.50	18.50	8.30	10.20	11.50	1.50	15.70	2.65	0.50
C2050-FS	31.75	9.53	10.16	5.08	20.50	22.50	10.30	12.20	15.10	2.00	25.50	4.31	0.80
C2060H-FS	38.10	12.70	11.91	5.95	29.10	31.50	14.60	16.90	17.20	3.20	37.30	6.28	1.40
C2080H-FS	50.80	15.88	15.88	7.93	35.80	39.00	17.90	21.10	22.80	4.00	63.70	10.70	2.40

*Standard sprocket is available.

*Attachment can be installed.

Large Roller

Chain No.	Dimensions - mm										Average Ultimate Strength kN	Maximum Allowable Load kN	Average Chain Weight kg/m
	Pitch	Roller		Pin				Plate					
		Width	Dia.	Dia.	Length			Height	Thick.				
	P	W	R	D	L _R	L _C	L ₁	L ₂	H	T			
C2042-FS	25.40	7.95	15.88	3.96	16.50	18.50	8.30	10.20	11.50	1.50	15.70	2.65	1.00
C2052-FS	31.75	9.53	19.05	5.08	20.50	22.50	10.30	12.20	15.10	2.00	25.50	4.31	1.60
C2062H-FS	38.10	12.70	22.23	5.95	29.10	31.50	14.60	16.90	17.20	3.20	37.30	6.28	2.80
C2082H-FS	50.80	15.88	28.58	7.93	35.80	39.00	17.90	21.10	22.80	4.00	63.70	10.70	4.60

*Standard sprocket is available.

*Attachment can be installed.

Lubeless Chains (O-ring Chain)

Loss of oil coverage between pins and bushes is one factor controlling the lifespan of a chain. O-ring chains are equipped with O-rings to prevent this loss of oil coverage. Therefore, these chains are suitable for use in situations where it is difficult or impossible to oil the chain, in environments where oiling (lubricant oil) is not tolerated, or in very dusty environments.

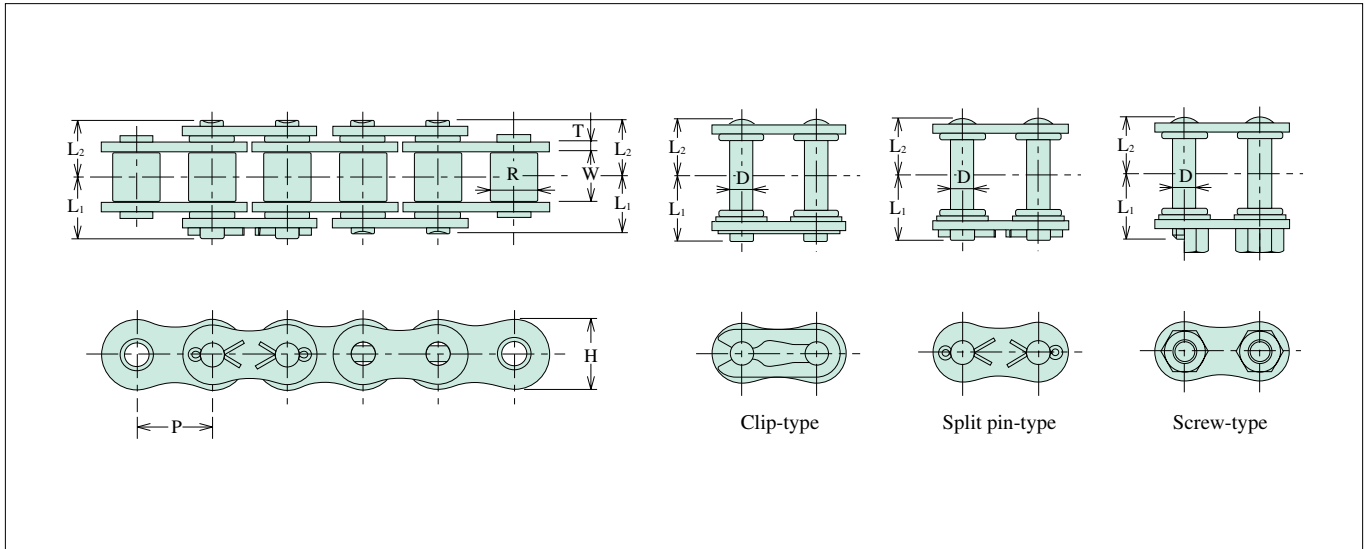

Chain No.	Dimensions - mm								Minimum Ultimate Strength		Maximum Allowable Load		Weight kg/m
	Pitch P	Roller		Pin		Plate							
		Width W	Dia. R	Dia. D	Length L ₁	Length L ₂	Height H	Thickness T	kN	kgf	kN	kgf	
40BO	12.70	7.94	7.94	3.96	9.70	9.70	12.00	1.50	18.10	1850	3.33	340	0.67
50BO	15.875	9.50	10.16	5.08	11.45	11.45	15.00	2.00	31.40	3200	5.88	600	1.11
60BO	19.05	12.70	11.91	5.95	14.30	14.30	17.80	2.40	44.60	4550	8.23	840	1.60
80BO	25.40	15.88	15.88	7.93	18.70	18.70	23.00	3.20	70.60	7200	13.70	1400	2.72
100BO	31.75	19.05	19.05	9.53	22.10	22.10	29.70	4.00	116.00	11800	20.50	2100	4.27
120BO	38.10	25.40	22.23	11.10	31.50	28.30	35.30	4.80	157.00	16000	28.40	2900	6.18
140BO	44.45	25.40	25.40	12.70	34.70	30.75	42.20	5.60	204.00	20800	37.20	3800	7.97
160BO	50.80	31.75	28.58	14.28	41.00	36.65	48.20	6.40	258.00	26300	49.00	5000	10.32
180BO	57.15	35.72	35.71	17.46	46.00	41.05	54.20	7.20	332.00	33900	56.80	5800	13.99
200BO	63.50	38.10	39.69	19.84	50.30	44.80	60.30	8.00	425.00	43300	66.60	6800	17.93
240BO	76.20	47.63	47.63	23.81	61.30	54.85	72.40	9.60	629.00	64170	92.10	9400	25.48
C2040BO	25.40	7.94	7.94	3.96	11.45	9.70	12.00	1.50	16.70	1700	3.33	340	0.51
C2050BO	31.75	9.53	10.16	5.08	13.60	11.45	15.00	2.00	27.50	2800	5.88	600	0.84
C2060BO	38.10	12.70	11.91	5.95	18.65	15.55	17.00	3.20	44.60	4550	8.23	840	1.43
C2080BO	50.80	15.88	15.88	7.94	19.35	19.35	23.00	4.00	70.60	7200	13.70	1400	2.44

Note: ※ 1. Offset links are not available.

2. Clip-type connecting links are supplied for 40BO-80BO, Split pin-type for 100BO and C2040BO-C2080BO and Screw-type for 120BO-240BO.

Caution

O-ring chains have lubricant oil seal between pin and bush. Caution must be taken not to spill the sealed oil when assembling or disassembling chain. The chain is worn out rapidly in case that the oil leaks out.

Heavy Duty Drive Chains

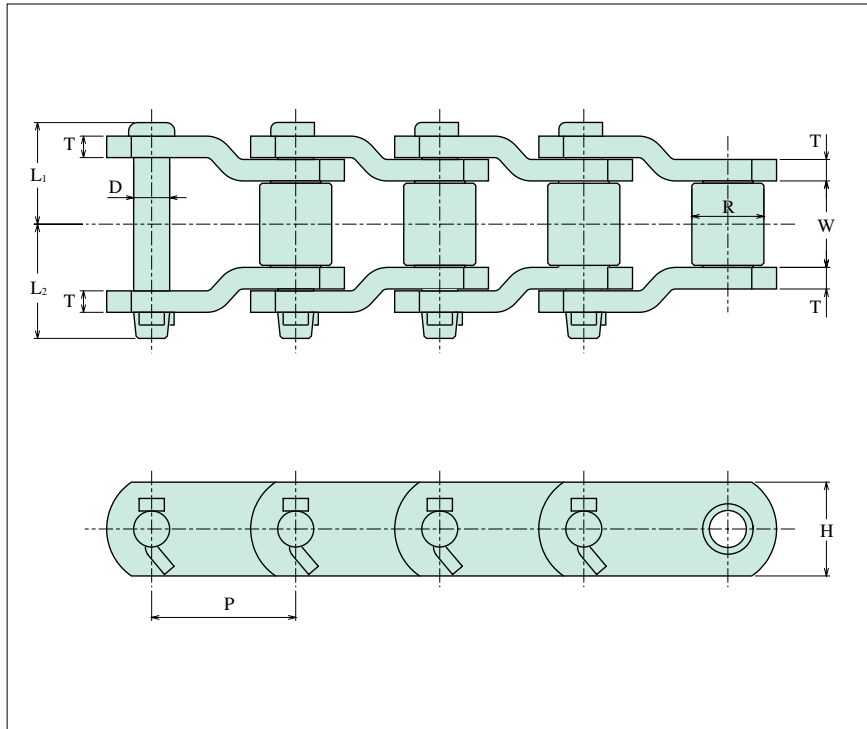

These chains are suitable for power transmission in machines which are subjected to extremely large forces and shocks, such as civil engineering, construction and oil drilling equipment. Heat-treated special steel is used for their main components, and they are machined to high precision. These are offset-type chains, which give them superior impact resistance.

Chain No.	Dimensions (mm)								Average Ultimate Strength		Weight
	Pitch	Roller		Pin		Plate					
		P	Width	Dia.	Dia.	Length	Height	Thickness	kN	kgf	kg/m
H2570H	63.50	38.10	31.75	15.88	44.80	50.30	41.30	9.50	333	34000	13.90
H3011	77.90	39.70	41.28	19.05	45.60	54.30	57.20	9.50	490	50000	19.80
HP3H	78.11	38.10	31.75	15.88	44.80	50.30	41.30	9.50	333	34000	12.20
H3125	79.38	41.30	41.28	20.32	46.40	55.10	57.20	9.50	510	52000	19.90
H238	88.90	38.10	44.45	22.20	51.30	59.80	57.20	12.70	623	63500	24.40
H1242	103.20	49.20	44.45	22.23	56.80	65.40	57.20	12.70	623	63500	23.80
HP4H	103.20	49.00	44.45	23.23	63.30	73.70	58.70	15.90	755	77000	28.90
H1245	103.45	49.20	45.24	23.83	60.00	69.00	60.30	14.30	755	77000	27.60
H635	114.30	52.40	57.15	27.80	61.60	73.40	76.20	14.30	981	100000	37.60
H1602A	127.00	69.80	63.50	31.75	73.50	84.70	88.90	15.90	1245	127000	50.80
H6042	152.40	76.30	76.20	38.10	85.80	93.80	101.60	19.00	1863	190000	67.40

It is stocks class

H10199	101.60	58.70	57.15	28.58	61.50	72.50	76.20	12.70	978	99700	37.70
H10398	103.89	49.20	47.63	25.40	60.00	70.00	76.20	14.30	961	98000	34.70
H127170	127.00	69.90	63.50	34.90	84.30	89.80	91.00	19.00	1765	180000	60.10

It is extra workmanship (It takes the appointed date of delivery)

Double Pitch Roller Chains (For Drive)

Double Pitch Roller Chains for power transmission have gourd-shaped link plates. Applications are mainly light loads with relatively long sprocket center distances.

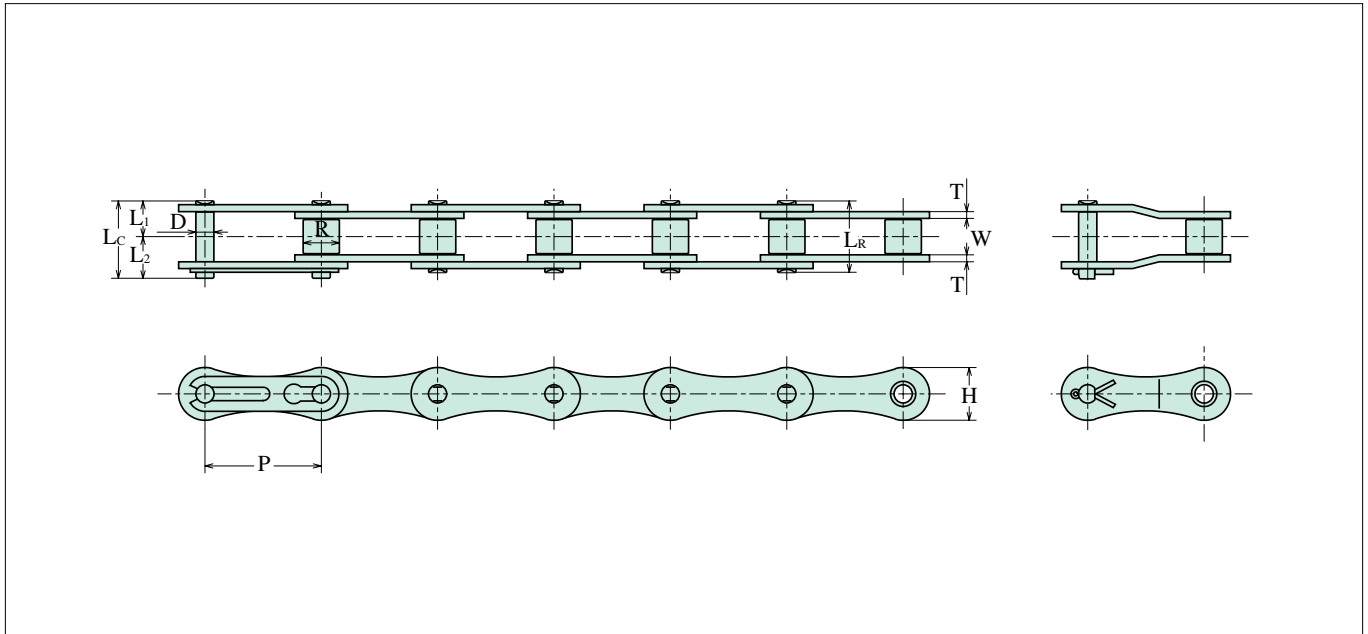

Chain No.	Dimensions - mm										Average Ultimate Strength kN	Maximum Allowable Load kN	Average Chain Weight kg/m
	Pitch P	Roller		Pin				Plate					
		Width W	Dia. R	Dia. D	Length			Height H	Thick. T				
					LR	LC	L1	L2					
A 2040	25.40	7.95	7.92	3.96	16.50	17.90	9.30	9.60	11.40	1.50	16.90	3.63	0.43
A 2050	31.75	9.53	10.16	5.08	20.40	22.00	10.20	11.80	15.00	2.00	27.50	6.28	0.73
A 2060	38.10	12.70	11.91	5.95	25.50	26.90	12.80	14.10	17.00	2.40	40.20	8.60	1.03
A 2080	50.80	15.88	15.88	7.93	32.80	35.20	16.40	18.80	22.60	3.20	68.60	14.70	1.71

Double Pitch Roller Chains (For Conveyor)

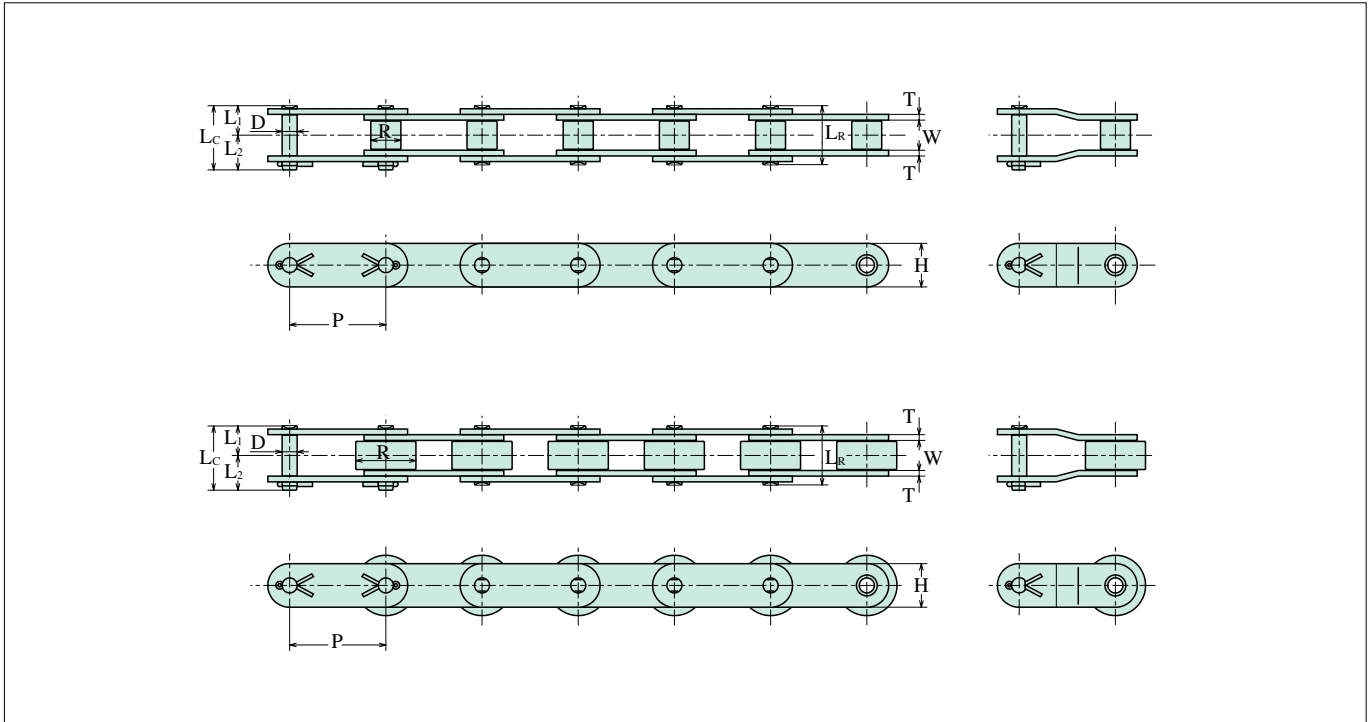

Small Roller

Chain No.	Dimensions - mm										Average Ultimate Strength kN	Maximum Allowable Load kN	Average Chain Weight kg/m
	Pitch P	Roller		Pin				Plate					
		Width W	Dia. R	Dia. D	Length			Height H	Thick. T				
				LR	LC	L1	L2						
C2040	25.40	7.95	7.92	3.96	16.50	18.50	8.20	10.30	11.40	1.50	16.90	3.63	0.48
C2050	31.75	9.53	10.16	5.08	20.40	22.00	10.20	11.80	15.00	2.00	27.50	6.28	0.82
C2060H	38.10	12.70	11.91	5.95	28.70	31.00	14.40	16.60	17.00	3.20	40.20	8.63	1.38
C2080H	50.80	15.88	15.88	7.93	35.50	38.80	17.80	21.00	22.60	4.00	68.60	14.70	2.32
C2100H	63.50	19.05	19.05	9.53	42.20	45.70	21.10	24.60	28.60	4.80	107.90	22.60	3.46
C2120H	76.20	25.40	22.23	11.10	52.60	57.00	26.30	30.70	34.90	5.60	151.00	30.40	4.92
C2160H	101.60	31.75	28.58	14.28	67.70	72.90	33.90	39.00	47.60	7.20	257.90	53.00	8.02

Large Roller

Chain No.	Dimensions - mm										Average Ultimate Strength kN	Maximum Allowable Load kN	Average Chain Weight kg/m
	Pitch P	Roller		Pin				Plate					
		Width W	Dia. R	Dia. D	Length			Height H	Thick. T				
				LR	LC	L1	L2						
C2042	25.40	7.95	15.88	3.96	16.50	18.50	8.20	10.30	11.40	1.50	16.90	3.63	0.82
C2052	31.75	9.53	19.05	5.08	20.40	22.00	10.20	11.80	15.00	2.00	27.50	6.28	1.26
C2062H	38.10	12.70	22.23	5.95	28.70	31.00	14.40	16.60	17.00	3.20	40.20	8.63	2.08
C2082H	50.80	15.88	28.58	7.93	35.50	38.80	17.80	21.00	22.60	4.00	68.60	14.70	3.36
C2102H	63.50	19.05	39.67	9.53	42.20	45.70	21.10	24.60	28.60	4.80	107.90	22.60	5.64
C2122H	76.20	25.40	44.45	11.10	52.60	57.00	26.30	30.70	34.90	5.60	151.00	30.40	7.87
C2162H	101.60	31.75	57.15	14.28	67.70	72.90	33.90	39.00	47.60	7.20	257.90	53.00	12.77

Hollow Pin Chains

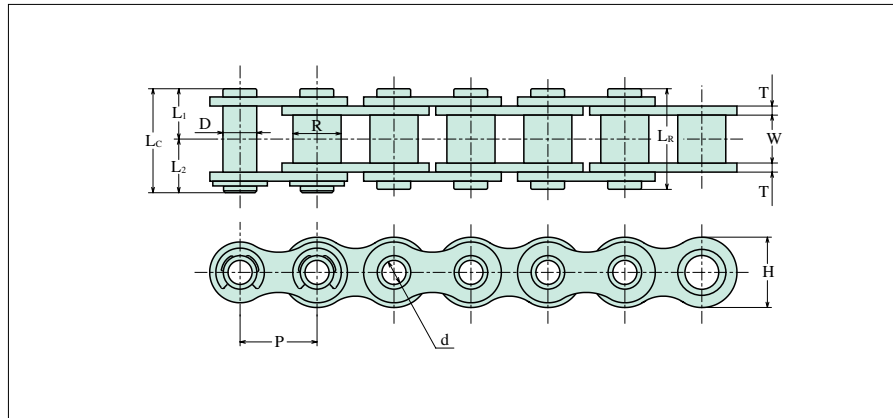

These Chains have "Hollow Pin", various pins and the attachments can be installed by using it.

HP STANDARD

Chain No.	Dimensions - mm											Average Ultimate Strength	Maximum Allowable Load	Weight
	Pitch	Bushing		Hollows Pin						Plate				
		Width	Dia.	Outside	Inside	Length				Height	Thick.			
P	W	R	D	d	LR	LC	L1	L2	H	T				
40HP	12.70	7.95	7.92	5.63	4.03	16.70	17.60	8.40	9.20	12.00	1.50	12.70	1.77	0.58
50HP	15.875	9.53	10.16	7.09	5.13	20.10	21.30	10.10	11.20	15.00	2.00	19.60	3.14	0.97
60HP	19.05	12.70	11.91	8.29	6.04	26.00	27.20	13.00	14.20	18.10	2.40	28.40	4.22	1.46
80HP	25.40	15.88	15.88	11.34	8.08	32.40	34.30	16.20	18.10	24.10	3.20	51.00	7.70	2.47

Double Pitch Hollow Pin Chains

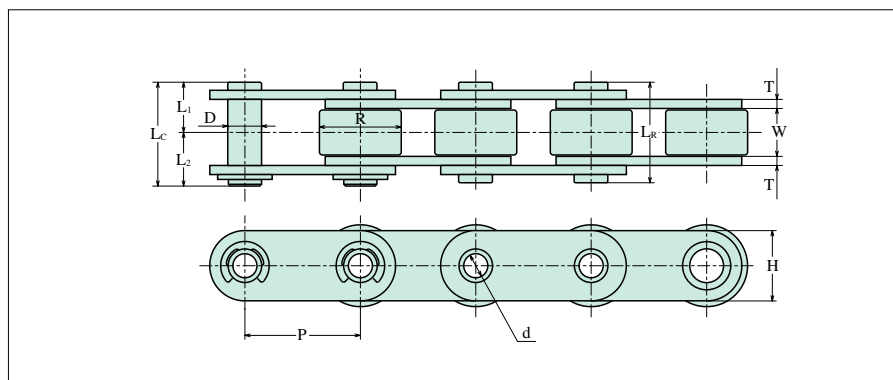

HP DOUBLE PITCH

Chain No.	Dimensions - mm											Average Ultimate Strength	Maximum Allowable Load	Weight
	Pitch	Roller		Hollows Pin						Plate				
		Width	Dia.	Outside	Inside	Length				Height	Thick.			
P	W	R	D	d	LR	LC	L1	L2	H	T				
C2040HP	25.40	7.95	7.92	5.63	4.03	16.70	17.60	8.40	9.20	12.00	1.50	12.70	1.77	0.46
C2050HP	31.75	9.53	10.16	7.09	5.13	20.10	21.30	10.10	11.20	15.00	2.00	19.60	3.14	0.76
C2060HP	38.10	12.70	11.91	8.29	6.04	26.00	27.20	13.00	14.20	18.10	2.40	28.40	4.22	1.12
C2080HP	50.80	15.88	15.88	11.34	8.08	32.40	34.30	16.20	18.10	24.10	3.20	51.00	7.70	1.98
C2042HP	25.40	7.95	15.88	5.63	4.03	16.70	17.60	8.40	9.20	12.00	1.50	12.70	1.77	0.81
C2052HP	31.75	9.53	19.05	7.09	5.13	20.10	21.30	10.10	11.20	15.00	2.00	19.60	3.14	1.25
C2062HP	38.10	12.70	22.23	8.29	6.04	26.00	27.20	13.00	14.20	18.10	2.40	28.40	4.22	1.79
C2082HP	50.80	15.88	28.58	11.34	8.08	32.40	34.30	16.20	18.10	24.10	3.20	51.00	7.70	3.17

Note: ※C2040HP thru C2080HP are rollerless; R shows bushing dia.

Stainless Hollow Pin Chains

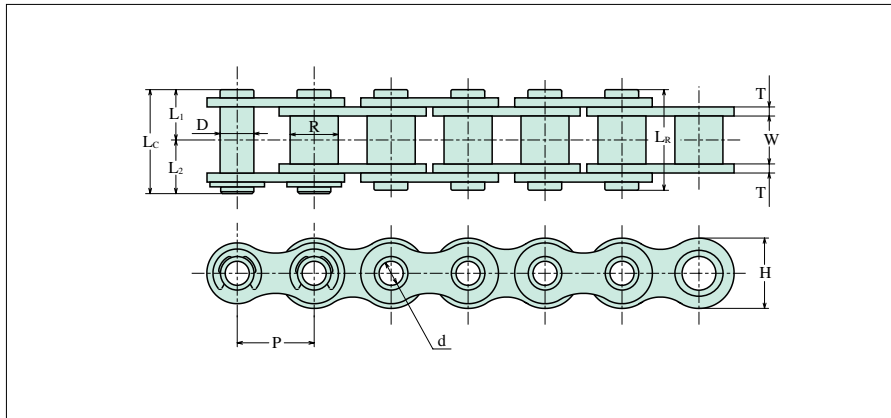

STAINLESS HP STANDARD

Chain No.	Dimensions - mm											Average Ultimate Strength	Maximum Allowable Load	Weight
	Pitch	Bushing		Hollows Pin						Plate				
		Width	Dia.	Outside	Inside	Length				Height	Thick.			
P	W	R	D	d	LR	LC	L1	L2	H	T				
40HP-SS	12.70	7.95	7.92	5.63	4.03	16.70	17.60	8.40	9.20	12.00	1.50	7.65	0.44	0.58
50HP-SS	15.875	9.53	10.16	7.09	5.13	20.10	21.30	10.10	11.20	15.00	2.00	11.80	0.69	0.97
60HP-SS	19.05	12.70	11.91	8.29	6.04	26.00	27.20	13.00	14.20	18.10	2.40	17.10	1.03	1.46
80HP-SS	25.40	15.88	15.88	11.34	8.08	32.40	34.30	16.20	18.10	24.10	3.20	31.00	1.77	2.47

Double Pitch Stainless Hollow Pin Chains

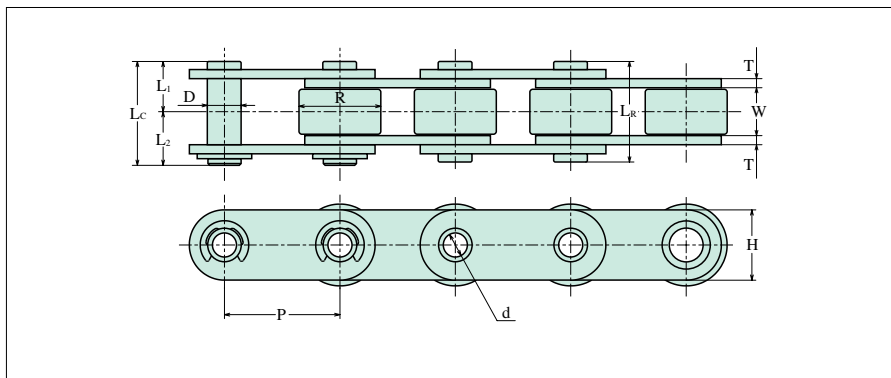

STAINLESS HP DOUBLE PITCH

Chain No.	Dimensions - mm											Average Ultimate Strength	Maximum Allowable Load	Weight
	Pitch	Roller		Hollows Pin						Plate				
		Width	Dia.	Outside	Inside	Length				Height	Thick.			
P	W	R	D	d	LR	LC	L1	L2	H	T				
C2040HP-SS	25.40	7.95	7.92	5.63	4.03	16.70	17.60	8.40	9.20	12.00	1.50	7.65	0.44	0.46
C2050HP-SS	31.75	9.53	10.16	7.09	5.13	20.10	21.30	10.10	11.20	15.00	2.00	11.80	0.69	0.76
C2060HP-SS	38.10	12.70	11.91	8.29	6.04	26.00	27.20	13.00	14.20	18.10	2.40	17.10	1.03	1.12
C2080HP-SS	50.80	15.88	15.88	11.34	8.08	32.40	34.30	16.20	18.10	24.10	3.20	31.00	1.77	1.98
C2042HP-SS	25.40	7.95	15.88	5.63	4.03	16.70	17.60	8.40	9.20	12.00	1.50	7.65	0.44	0.81
C2052HP-SS	31.75	9.53	19.05	7.09	5.13	20.10	21.30	10.10	11.20	15.00	2.00	11.80	0.69	1.25
C2062HP-SS	38.10	12.70	22.23	8.29	6.04	26.00	27.20	13.00	14.20	18.10	2.40	17.10	1.03	1.79
C2082HP-SS	50.80	15.88	28.58	11.34	8.08	32.40	34.30	16.20	18.10	24.10	3.20	31.00	1.77	3.17

Note: *C2040HP thru C2080HP are rollerless; R shows bushing dia.

Stainless Steel Chains

Stainless Steel Roller Chains are manufactured of class 300 stainless steel to ANSI & BS dimensional specifications. These chains are ideal for highly acidic or alkaline locations, or where the chain will be exposed to water, and for very high or very low temperature locations where resistance to corrosion and heat is a requirement.

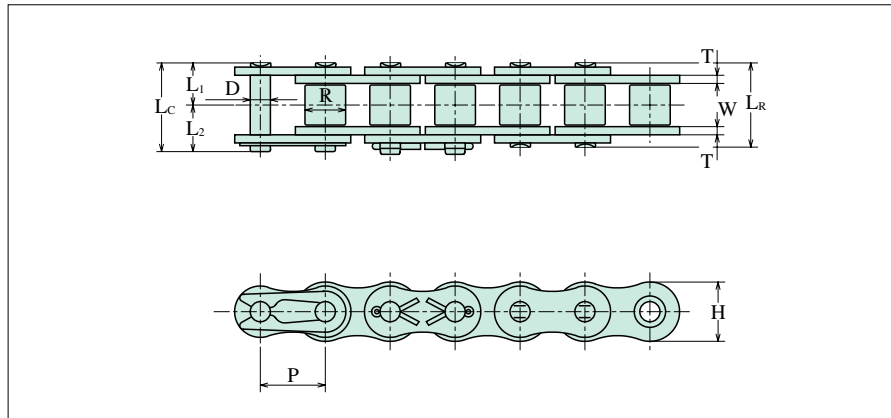

ANSI

Chain No.	Dimensions - mm										Minimum Ultimate Strength	Maximum Allowable Load	Average Chain Weight
	Pitch	Roller		Pin				Plate					
		Width	Dia.	Dia.	Length		Height	Thick.					
P	W	R	D	L _R	L _C	L ₁	L ₂	H	T	kN	kN	kg/m	
25-SS	6.35	3.20	※3.30	2.30	—	—	3.80	4.70	6.00	0.75	—	0.11	0.13
35-SS	9.525	4.78	※5.08	3.58	12.20	13.70	6.10	7.60	9.00	1.25	5.68	0.26	0.34
40-SS	12.70	7.95	7.92	3.96	16.90	18.50	8.50	10.00	11.70	1.50	11.10	0.44	0.60
50-SS	15.875	9.53	10.16	5.08	20.80	22.30	10.40	11.90	14.60	2.00	17.60	0.68	0.98
60-SS	19.05	12.70	11.91	5.95	26.00	27.90	13.00	14.90	17.50	2.40	24.50	1.03	1.46
80-SS	25.40	15.88	15.88	7.93	32.80	35.50	16.40	19.10	23.40	3.20	42.30	1.77	2.52
100-SS	31.75	19.05	19.05	9.53	40.00	43.30	20.00	23.30	29.30	4.00	51.00	2.55	3.91
120-SS	38.10	25.40	22.23	11.10	50.40	54.20	25.20	29.00	35.10	4.80	68.60	3.92	5.76
140-SS	44.45	25.40	25.40	12.70	54.00	58.30	27.00	31.30	40.90	5.60	88.20	4.66	7.41
160-SS	50.80	31.75	28.58	14.28	64.30	68.70	32.20	36.50	46.70	6.40	109.80	6.37	9.79

BS

06B-SS	9.525	5.72	6.35	3.28	12.60	13.40	6.30	7.10	8.20	1.00/1.25	6.18	0.27	0.43
08B-SS	12.70	7.75	8.51	4.45	16.70	18.00	8.40	9.60	11.80	1.50	10.30	0.52	0.61
10B-SS	15.875	9.65	10.16	5.08	19.00	20.70	9.50	11.20	14.70	1.65	15.70	0.68	0.89
12B-SS	19.05	11.68	12.07	5.72	22.00	23.60	11.00	12.60	16.10	1.80	18.10	0.88	1.14
16B-SS	25.40	17.02	15.88	8.26	35.10	38.20	17.60	20.60	20.30	3.20/4.00	42.20	2.06	2.59

Note: ※Chain is rollerless; R shows bushing dia.

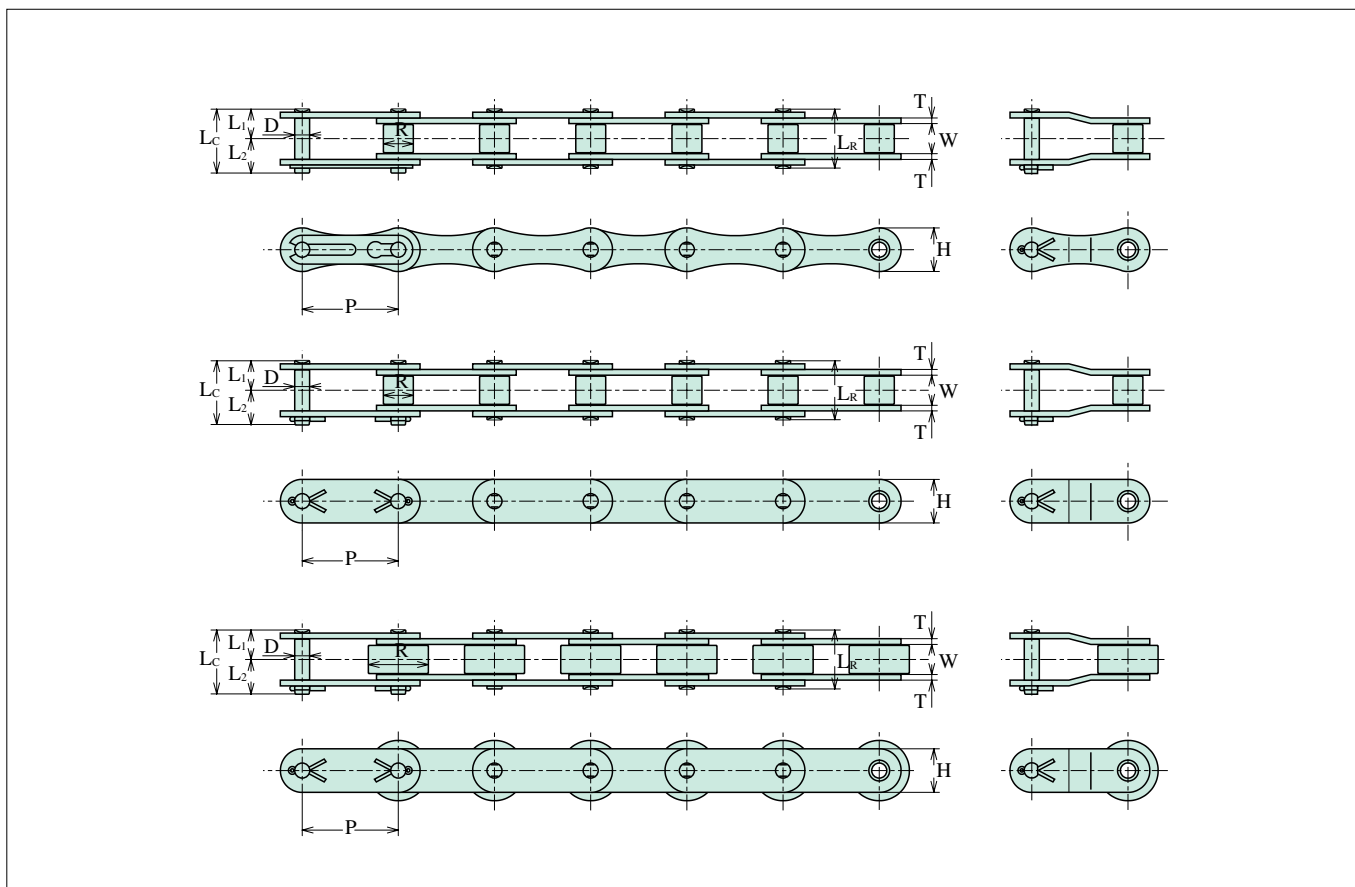

DOUBLE PITCH

Chain No.	Dimensions - mm										Average Ultimate Strength kN	Maximum Allowable Load kN	Average Chain Weight kg/m
	Pitch P	Roller		Pin				Plate					
		Width W	Dia. R	Dia. D	Length			Height H	Thick. T				
					L_R	L_C	L_1	L_2					
A 2040-SS	25.40	7.95	7.92	3.96	16.90	18.50	8.50	10.00	11.40	1.50	12.40	0.44	0.43
A 2050-SS	31.75	9.53	10.16	5.08	20.80	22.30	10.40	11.90	15.00	2.00	20.30	0.68	0.73
A 2060-SS	38.10	12.70	11.91	5.95	26.00	27.90	13.00	14.90	17.00	2.40	27.40	1.03	1.03
A 2080-SS	50.80	15.88	15.88	7.93	32.80	35.50	16.40	19.10	22.60	3.20	47.10	1.77	1.71
C 2040-SS	25.40	7.95	7.92	3.96	16.90	18.50	8.50	10.00	11.40	1.50	12.40	0.44	0.48
C 2050-SS	31.75	9.53	10.16	5.08	20.80	22.30	10.40	11.90	15.00	2.00	20.30	0.68	0.82
C 2060H-SS	38.10	12.70	11.91	5.95	28.80	30.90	14.40	16.50	17.00	3.20	27.40	1.03	1.38
C 2080H-SS	50.80	15.88	15.88	7.93	35.70	38.80	17.90	20.90	22.60	4.00	47.10	1.77	2.32
C 2100H-SS	63.50	19.05	19.05	9.53	42.40	46.00	21.20	24.80	28.60	4.80	56.90	2.55	3.46
C 2120H-SS	76.20	25.40	22.23	11.10	52.80	57.20	26.40	30.80	34.90	5.60	76.50	3.92	4.92
C 2042-SS	25.40	7.95	15.88	3.96	16.90	18.50	8.50	10.00	11.40	1.50	12.40	0.44	0.82
C 2052-SS	31.75	9.53	19.05	5.08	20.80	22.30	10.40	11.90	15.00	2.00	20.30	0.68	1.26
C 2062H-SS	38.10	12.70	22.23	5.95	28.80	30.90	14.40	16.50	17.00	3.20	27.40	1.03	2.08
C 2082H-SS	50.80	15.88	28.58	7.93	35.70	38.80	17.90	20.90	22.60	4.00	47.10	1.77	3.36
C 2102H-SS	63.50	19.05	39.67	9.53	42.40	46.00	21.20	24.80	28.60	4.80	56.90	2.55	5.64
C 2122H-SS	76.20	25.40	44.45	11.10	52.80	57.20	26.40	30.80	34.90	5.60	76.50	3.92	7.87

Nickel-Plated Chains

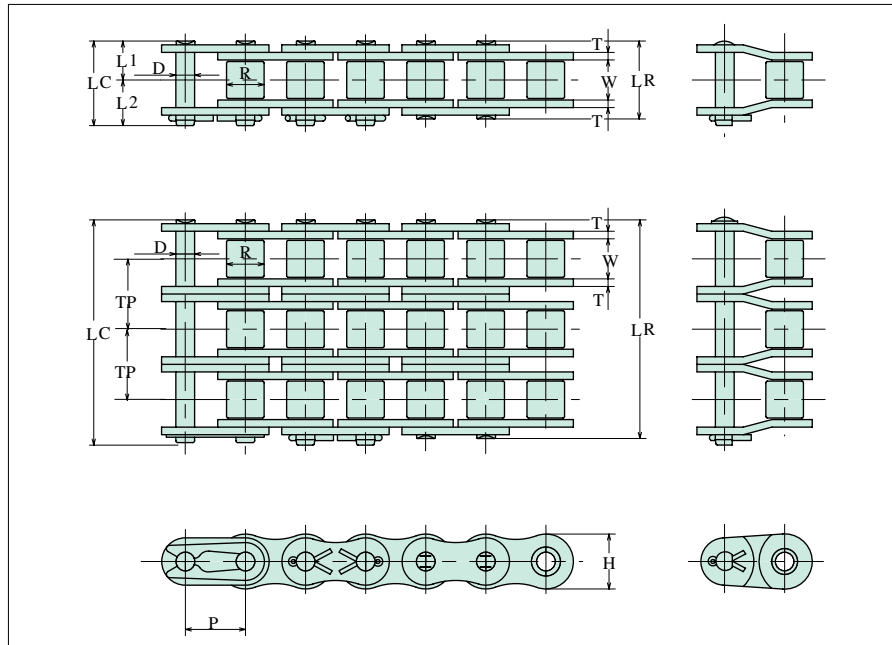

Nickel Plated Chains are manufactured for the usage of outdoor operations and in situations where machinery must be run in a lightly corrosive atmosphere or where good chain appearance may be desired.

ANSI

Chain No.	Dimensions - mm										Average Ultimate Strength kN	Maximum Allowable Load kN	Average Chain Weight kg/m	
	Pitch P	Roller		Pin				Plate		Trans. Pitch TP				
		Width W	Dia. R	Dia. D	Length		Height H	Thick. T						
					LR	LC	L1	L2						
35-NP	9.525	4.80	※5.08	3.58	12.00	12.90	6.00	6.90	8.90	1.25	/	10.80	2.48	0.34
40-NP	12.70	7.95	7.92	3.96	16.50	17.90	8.30	9.60	11.60	1.50		19.10	4.17	0.60
50-NP	15.875	9.53	10.16	5.08	20.40	22.00	10.20	11.80	14.50	2.00		31.90	7.22	0.98
60-NP	19.05	12.70	11.91	5.95	25.50	26.90	12.80	14.10	17.40	2.40		43.10	10.70	1.46
80-NP	25.40	15.88	15.88	7.93	32.80	35.10	16.40	18.70	23.40	3.20		78.50	19.10	2.52
100-NP	31.75	19.05	19.05	9.53	39.40	43.00	19.70	23.30	29.30	4.00		118.00	29.40	3.91
35-2NP	9.525	4.80	※5.08	3.58	22.10	23.00	11.10	11.90	8.90	1.25	10.10	21.60	3.67	0.63
40-2NP	12.70	7.95	7.92	3.96	30.80	32.20	15.40	16.80	11.60	1.50	14.40	38.20	6.17	1.22
50-2NP	15.875	9.53	10.16	5.08	38.40	40.00	19.20	20.80	14.50	2.00	18.10	63.80	10.70	2.00
60-2NP	19.05	12.70	11.91	5.95	48.20	49.70	24.00	25.70	17.40	2.40	22.80	86.20	14.70	2.95
80-2NP	25.40	15.88	15.88	7.93	61.60	64.50	30.80	33.70	23.40	3.20	29.30	157.00	25.00	5.10
100-2NP	31.75	19.05	19.05	9.53	75.10	78.80	37.60	41.20	29.30	4.00	35.80	236.00	38.40	7.74

BS

06B-NP	9.525	5.72	6.35	3.28	12.60	13.60	6.30	7.10	8.26	1.30/1.00	/	8.92	1.77	0.43
08B-NP	12.70	7.75	8.51	4.45	16.70	18.20	8.40	9.80	11.80	1.50		17.80	3.14	0.61
10B-NP	15.875	9.65	10.16	5.08	19.00	20.70	9.50	11.20	14.70	1.65		22.20	4.90	0.89
12B-NP	19.05	11.68	12.07	5.72	22.00	23.60	11.00	12.60	16.10	1.80		28.90	7.06	1.14
16B-NP	25.40	17.02	15.88	8.26	35.10	38.20	17.60	20.60	21.00	3.20		60.00	12.60	2.59
20B-NP	31.75	19.56	19.05	10.16	40.20	44.00	20.10	23.90	26.40	3.50		95.00	19.60	3.76
06B-2NP	9.525	5.72	6.35	3.28	22.90	23.85	11.50	12.20	8.26	1.30/1.00	10.24	16.90	3.00	0.81
08B-2NP	12.70	7.75	8.51	4.45	30.60	31.90	15.30	16.60	11.80	1.50	13.92	31.10	5.35	1.26
10B-2NP	15.875	9.65	10.16	5.08	35.60	37.30	17.80	19.50	14.70	1.65	16.59	44.50	8.33	1.79
12B-2NP	19.05	11.68	12.07	5.72	41.60	43.10	20.80	22.30	16.10	1.80	19.46	57.80	12.00	2.28
16B-2NP	25.40	17.02	15.88	8.26	67.20	70.10	33.60	36.50	20.60	3.20/4.00	31.88	106.00	21.40	5.13
20B-2NP	31.75	19.56	19.05	10.16	76.80	80.60	38.40	42.20	26.40	3.50/4.50	36.45	170.00	33.30	7.26

Note: ※ Chain is rollerless; R shows bushing dia.

Nickel-Plated Double Pitch Chains

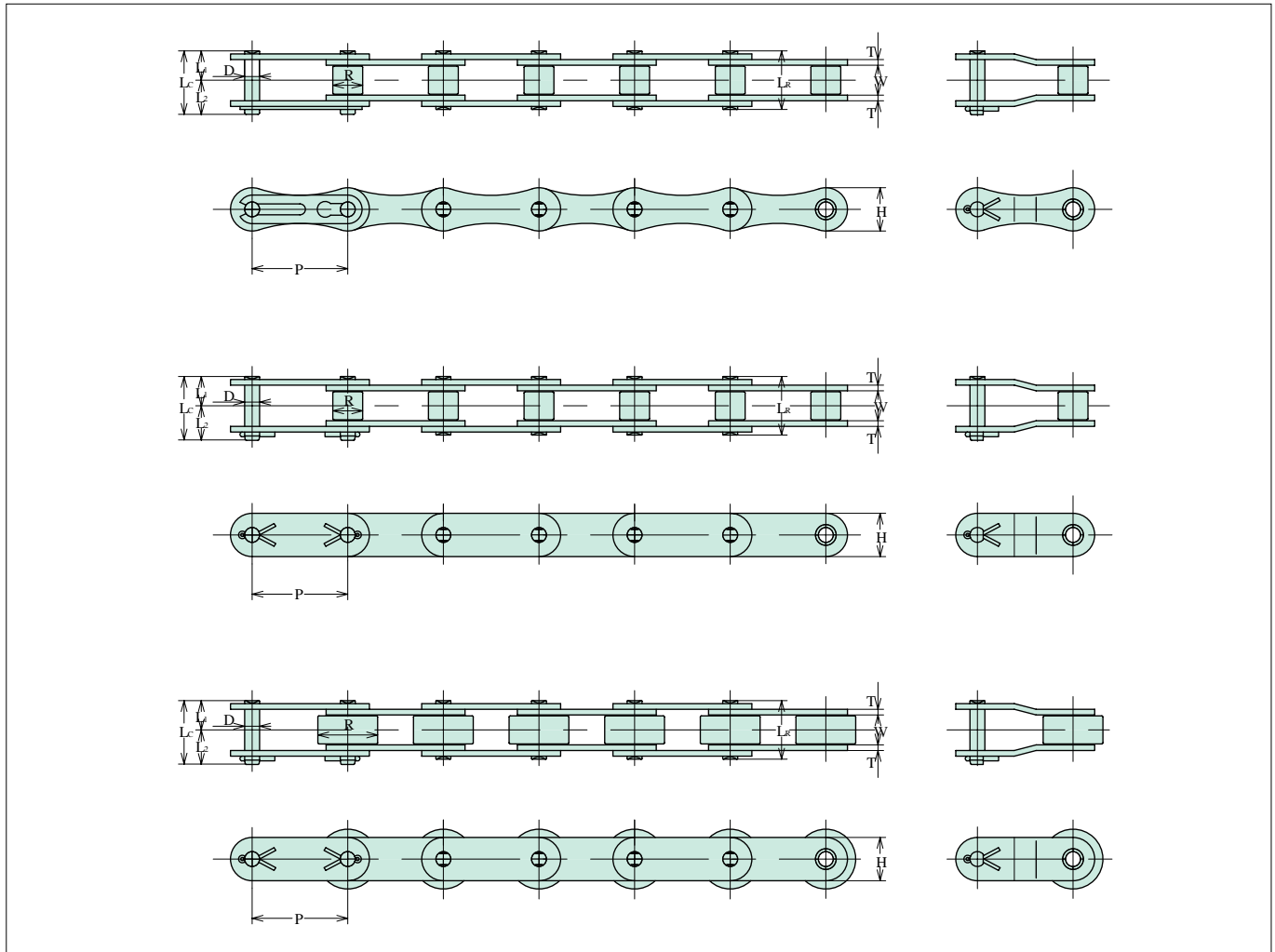

NP DOUBLE PITCH

Chain No.	Dimensions - mm										Average Ultimate Strength	Maximum Allowable Load	Average Chain Weight
	Pitch	Roller		Pin					Plate				
		Width	Dia.	Dia.	Length			Height	Thick.				
P	W	R	D	LR	Lc	L1	L2	H	T	kN	kN	kg/m	
A 2040-NP	25.40	7.95	7.92	3.96	16.50	17.90	9.30	9.60	11.40	1.50	16.90	3.63	0.43
A 2050-NP	31.75	9.53	10.16	5.08	20.40	22.00	10.20	11.80	15.00	2.00	27.50	6.28	0.73
A 2060-NP	38.10	12.70	11.91	5.95	25.50	26.90	12.80	14.10	17.00	2.40	40.20	8.63	1.03
A 2080-NP	50.80	15.88	15.88	7.93	32.80	35.20	16.40	18.80	22.60	3.20	68.60	14.70	1.71
C 2040-NP	25.40	7.95	7.92	3.96	16.50	18.50	8.20	10.30	11.40	1.50	16.90	3.63	0.48
C 2050-NP	31.75	9.53	10.16	5.08	20.40	22.00	10.20	11.80	15.00	2.00	27.50	6.28	0.82
C 2060H-NP	38.10	12.70	11.91	5.95	28.70	31.00	14.40	16.60	17.00	3.20	40.20	8.63	1.38
C 2080H-NP	50.80	15.88	15.88	7.93	35.50	38.80	17.80	21.00	22.60	4.00	68.60	14.70	2.32
C 2100H-NP	63.50	19.05	19.05	9.53	42.20	45.70	21.10	24.60	28.60	4.80	107.90	22.60	3.46
C 2042-NP	25.40	7.95	15.88	3.96	16.50	18.50	8.20	10.30	11.40	1.50	16.90	3.63	0.82
C 2052-NP	31.75	9.53	19.05	5.08	20.40	22.00	10.20	11.80	15.90	2.00	27.50	6.28	1.26
C 2062H-NP	38.10	12.70	22.23	5.95	28.70	31.00	14.40	16.60	17.00	3.20	40.20	8.63	2.08
C 2082H-NP	50.80	15.88	28.58	7.93	35.50	38.80	17.80	21.00	22.60	4.00	68.60	14.70	3.36
C 2102H-NP	63.50	19.05	39.67	9.53	42.20	45.70	21.10	24.60	28.60	4.80	107.90	22.60	5.64

Side Bow Chains

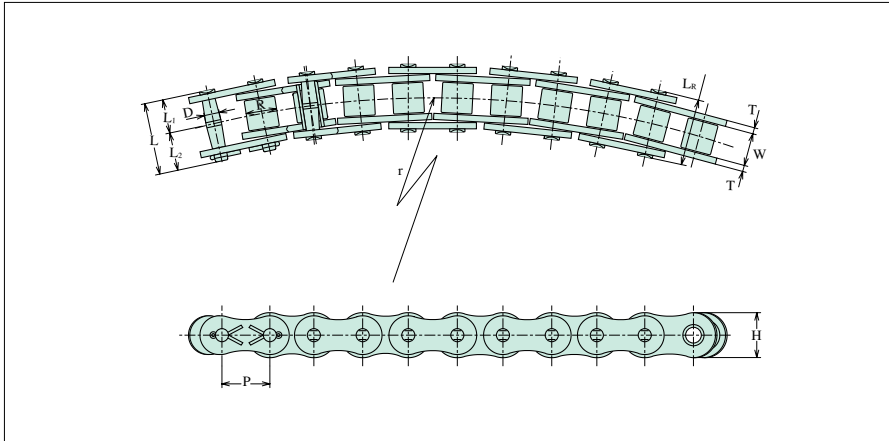

In Side Bow Chains, pin-to-bushing clearance are much greater than in standard roller chains and double pitch roller chains, and these, plus the clearances between inner and outer links, enable the chain to be used while bowed transversely. Basic dimensions conform to ANSI chains dimensions, enable standard sprockets to be utilized.

SB STANDARD

Chain No.	Dimensions - mm											Average Ultimate Strength kN	Maximum Allowable Load kN	Average Chain Weight kg/m
	Pitch P	Roller		Pin				Plate		Min. Curve Radius r				
		Width W	Dia. R	Out Dia. D	Length			Height H	Thick. T					
				LR	LC	L1	L2							
40SB	12.70	7.95	7.92	3.58	16.90	18.90	8.50	10.40	11.70	1.50	350	14.90	1.77	0.63
50SB	15.875	9.53	10.16	4.45	21.10	23.10	10.60	12.50	14.60	2.00	400	22.10	3.14	1.03
60SB	19.05	12.70	11.91	5.08	26.30	28.10	13.20	14.90	17.50	2.40	500	29.40	4.22	1.46
80SB	25.40	15.88	15.88	7.13	33.40	36.40	16.70	19.70	23.40	3.20	600	57.90	7.65	2.42

○Stainless steel, nickel plated, and with attachments are supplied on request.

Side Bow Double Pitch Chains

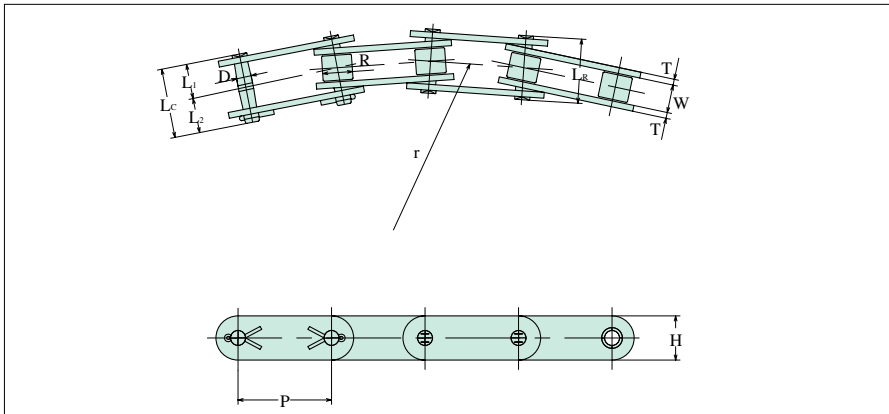

SB DOUBLE PITCH

Chain No.	Dimensions - mm											Average Ultimate Strength kN	Maximum Allowable Load kN	Average Chain Weight kg/m
	Pitch P	Roller		Pin				Plate		Min. Curve Radius r				
		Width W	Dia. R	Out Dia. D	Length			Height H	Thick. T					
				LR	LC	L1	L2							
C 2040SB	25.40	7.95	7.92	3.58	16.90	18.90	8.50	10.40	11.40	1.50	700	14.90	1.77	0.48
C 2050SB	31.75	9.53	10.16	4.45	21.10	23.10	10.60	12.50	15.00	2.00	800	22.10	3.14	0.82
C 2060SB	38.10	12.70	11.91	5.08	26.30	28.10	13.20	14.90	17.00	2.40	1000	29.40	4.22	1.20
C 2042SB	25.40	7.95	15.88	3.58	16.90	18.90	8.50	10.40	11.40	1.50	700	14.90	1.77	0.82
C 2052SB	31.75	9.53	19.05	4.45	21.10	23.10	10.60	12.50	15.00	2.00	800	22.10	3.14	1.26
C 2062SB	38.10	12.70	22.23	5.08	26.30	28.10	13.20	14.90	17.00	2.40	1000	29.40	4.22	2.01

Leaf Chains

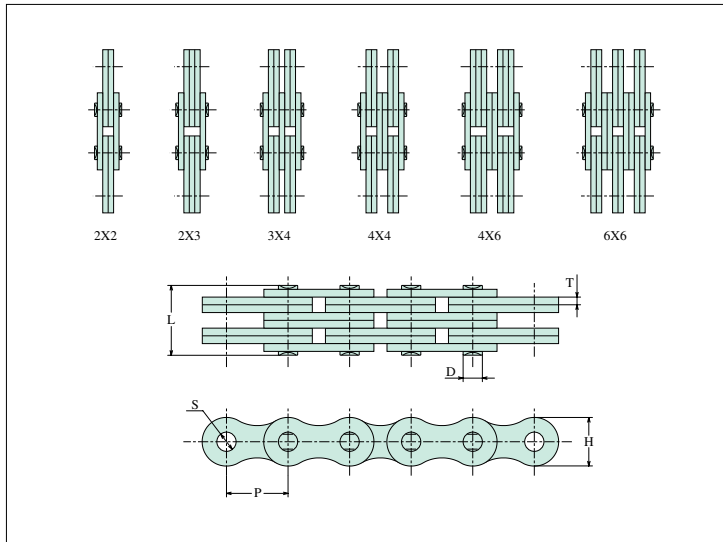

Leaf chains are well suited for any application requiring flexible, high strength linkage for reciprocating motion or lift at relatively low speed. For their low cost and long life, widely used for lift trucks, masts and other lifting as construction and mining machines and excellent as balance and counterweights of machine tools and so forth.

CONSTRUCTION AND LACING COMBINATIONS

Built of interlaced plates held together by riveted pins. The chain nomenclature indicates the lacing combinations.

AL SERIES (LIGHT DUTY)

Consisting of link plates of the same contour and thickness as the pin link plates of ANSI roller chains in same pitch. Mainly used for relatively constant, low, medium load with less shock.

Chain No.	Lacing	Dimensions - mm						Average Ultimate Strength	Maximum Allowable Load	Weight
		Pitch	Pin		Plate		Hole Dia			
			Dia.	Length	Height	Thickness				
P	D	L	H	T	S	kN	kN	kg/m		
AL422	2X2			8.40				18.60	1.86	0.36
AL444	4X4	12.70	3.96	14.60	10.30	1.50	4.03	37.30	3.43	0.70
AL466	6X6			21.20				55.90	3.92	1.04
AL522	2X2			10.50				30.40	3.04	0.58
AL544	4X4	15.875	5.08	19.00	12.70	2.00	5.15	60.80	5.30	1.16
AL566	6X6			27.60				94.10	6.28	1.73
AL622	2X2			12.40				43.10	4.41	0.81
AL644	4X4	19.05	5.95	22.20	15.20	2.40	6.04	86.30	7.45	1.68
AL666	6X6			32.60				129.00	8.73	2.46
AL822	2X2			16.60				72.60	7.35	1.42
AL844	4X4	25.40	7.93	29.40	20.20	3.20	8.00	145.00	13.20	2.88
AL866	6X6			43.00				218.00	15.40	4.23
AL1022	2X2			19.60				108.00	11.60	2.46
AL1044	4X4	31.75	9.53	36.20	24.50	4.00	9.59	216.00	20.60	4.81
AL1066	6X6			53.50				324.00	24.00	7.24
AL1222	2X2			24.00				152.00	16.50	3.35
AL1244	4X4	38.10	11.10	43.70	29.20	4.80	11.22	304.00	29.10	6.58
AL1266	6X6			63.40				456.00	34.20	9.82
AL1422	2X2			27.80				205.00	22.10	4.99
AL1444	4X4	44.45	12.70	51.20	34.20	5.60	12.82	410.00	38.90	9.56
AL1466	6X6			73.60				615.00	46.10	14.13
AL1622	2X2			31.80				269.00	28.30	6.35
AL1644	4X4	50.80	14.28	58.40	40.30	6.40	14.47	539.00	49.90	12.62
AL1666	6X6			84.80				809.00	58.80	18.87

BL SERIES (HEAVY DUTY)

Consisting of link plates with next large size pitch chain of ANSI roller chains. Chiefly used for medium load with greater shock.

Chain No.	Lacing	Dimensions - mm						Average Ultimate Strength	Maximum Allowable Load	Weight
		Pitch	Pin		Plate		Hole Dia			
			Dia.	Length	Height	Thickness				
P	D	L	H	T	S	kN	kN	kg/m		
BL422	2×2	12.70	5.08	10.50	11.70	2.00	5.15	27.50	4.51	0.64
BL423	2×3			12.50						
BL434	3×4			16.80						
BL444	4×4			19.00						
BL446	4×6			23.00						
BL466	6×6			27.50						
BL522	2×2	15.875	5.95	12.40	14.60	2.40	6.04	42.70	6.86	1.01
BL523	2×3			15.00						
BL534	3×4			20.00						
BL544	4×4			22.20						
BL546	4×6			27.60						
BL566	6×6			32.40						
BL622	2×2	19.05	7.93	16.60	17.50	3.20	8.00	70.60	9.81	1.53
BL623	2×3			19.50						
BL634	3×4			26.20						
BL644	4×4			29.20						
BL646	4×6			36.50						
BL666	6×6			43.00						
BL822	2×2	25.40	9.53	19.60	24.00	4.00	9.59	114.00	17.00	2.57
BL823	2×3			23.80						
BL834	3×4			32.50						
BL844	4×4			36.20						
BL846	4×6			45.00						
BL866	6×6			53.50						
BL1022	2×2	31.75	11.10	24.00	29.30	4.80	11.20	157.00	26.00	3.73
BL1023	2×3			28.60						
BL1034	3×4			38.70						
BL1044	4×4			43.70						
BL1046	4×6			53.40						
BL1066	6×6			63.40						
BL1222	2×2	38.10	12.70	27.80	35.10	5.60	12.82	207.00	36.80	4.77
BL1223	2×3			34.20						
BL1234	3×4			45.50						
BL1244	4×4			51.20						
BL1246	4×6			62.60						
BL1266	6×6			73.60						
BL1422	2×2	44.45	14.28	31.80	40.90	6.40	14.39	270.00	49.00	7.87
BL1423	2×3			38.80						
BL1434	3×4			51.70						
BL1444	4×4			58.40						
BL1446	4×6			71.20						
BL1466	6×6			84.80						
BL1622	2×2	50.80	17.45	35.80	46.70	7.20	17.62	392.00	58.80	9.77
BL1623	2×3			43.70						
BL1634	3×4			58.90						
BL1644	4×4			65.90						
BL1646	4×6			80.20						
BL1666	6×6			96.20						
								1176.00	137.30	28.54

LL SERIES

Consisting of link plates of the same contour and thickness as the pin link plates of BS roller chains in same pitch.

Chain No.	Lacing	Dimensions - mm						Minimum Ultimate Strength kN	Weight kg/m
		Pitch P	Pin		Plate		Hole Dia S		
			Dia. D	Length L	Height H	Thickness T			
LL0822	2×2			7.60				17.80	0.31
LL0844	4×4	12.70	4.45	13.00	10.90	1.25	4.46	31.10	0.60
LL0866	6×6			18.40				44.50	0.89
LL1022	2×2			9.30				22.20	0.48
LL1044	4×4	15.875	5.08	16.10	13.70	1.65	5.09	44.50	0.94
LL1066	6×6			22.90				66.70	1.40
LL1222	2×2			10.70				28.90	0.63
LL1244	4×4	19.05	5.72	18.50	16.10	1.80	5.73	57.80	1.22
LL1266	6×6			26.30				86.70	1.82
LL1622	2×2			17.20				58.00	1.48
LL1644	4×4	25.40	8.28	30.20	21.00	3.20	8.30	116.00	2.90
LL1666	6×6			43.20				174.00	4.31
LL2022	2×2			20.10				95.00	2.17
LL2044	4×4	31.75	10.19	35.10	26.40	3.50	10.21	190.00	4.24
LL2066	6×6			50.10				285.00	6.30
LL2422	2×2			28.40				170.00	4.02
LL2444	4×4	38.10	14.63	49.40	33.40	4.80	14.65	340.00	7.79
LL2466	6×6			70.40				510.00	11.55
LL2822	2×2			34.00				200.00	5.42
LL2844	4×4	44.45	15.90	60.00	37.00	6.30	15.92	400.00	10.56
LL2866	6×6			86.00				600.00	15.71
LL3222	2×2			35.00				260.00	5.92
LL3244	4×4	50.80	17.81	61.00	42.20	6.30	17.83	520.00	11.50
LL3266	6×6			87.00				780.00	17.06

ANSI Standard Attachment Chains

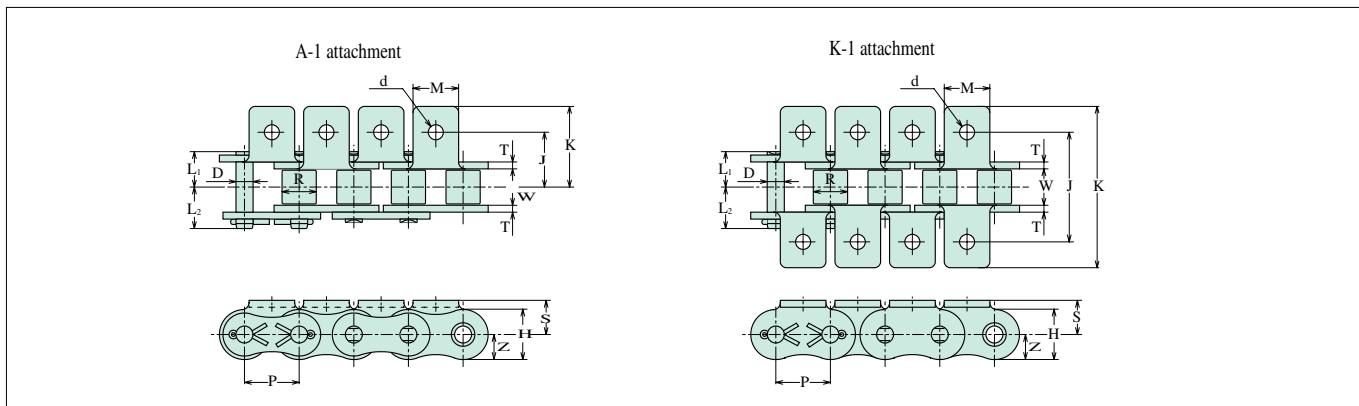

A-1,K-1 ATTACHMENT

Chain No.	Common Dimensions				Original Dimensions				Additional Weight	
	M	d	S	Z	A-1		K-1		A-1	K-1
					J	K	2J	2K	g/pc	
35	7.90	3.40	6.40	4.50	9.50	14.30	19.10	28.60	0.90	1.80
40	9.50	3.60	7.90	5.80	12.70	17.30	25.40	34.60	1.20	2.40
50	12.70	5.20	10.30	7.30	15.90	23.30	31.80	46.60	4.00	8.00
60	15.90	5.20	11.90	8.70	19.10	28.10	38.10	56.20	6.50	13.00
80	19.10	6.80	15.90	11.70	25.40	35.90	50.80	71.80	13.00	26.00
100	25.40	8.80	19.80	14.60	31.80	44.30	63.60	88.60	27.00	54.00
120	28.60	10.50	23.00	17.50	38.10	54.70	76.20	109.40	47.00	94.00
140	34.70	12.00	28.60	20.40	44.50	63.20	89.00	126.40	65.00	130.00
160	38.10	14.00	31.80	23.30	50.80	71.90	101.60	143.80	88.00	176.00

Note: Refer to the standard roller chain for dimensions not stated here.

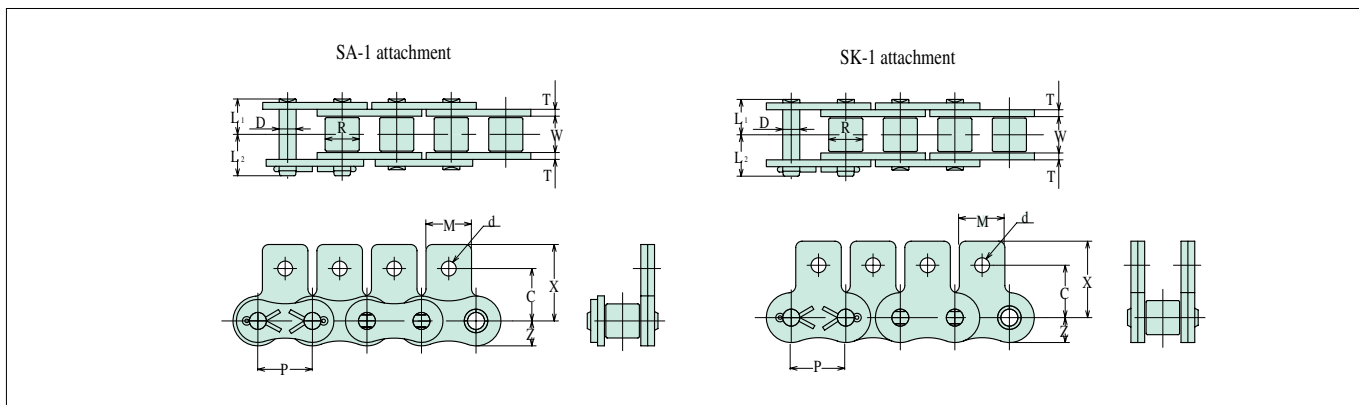

SA-1,SK-1 ATTACHMENT

Chain No.	Common Dimensions					Additional Weight	
	M	d	C	X	Z	SA-1	SK-1
						g/pc	
35	7.90	3.40	9.50	14.50	4.50	0.90	1.80
40	9.50	3.60	12.70	18.50	5.80	1.20	2.40
50	12.70	5.20	15.90	23.00	7.30	4.00	8.00
60	15.90	5.20	18.30	26.70	8.70	6.50	13.00
80	19.10	6.80	24.60	34.50	11.70	13.00	26.00
100	25.40	8.80	31.80	43.00	14.60	27.00	54.00
120	28.60	10.50	36.60	51.40	17.50	47.00	94.00
140	34.70	12.00	44.40	63.10	20.40	65.00	130.00
160	38.10	14.00	50.80	69.50	23.30	88.00	176.00

Note: Refer to the standard roller chain for dimensions not stated here.

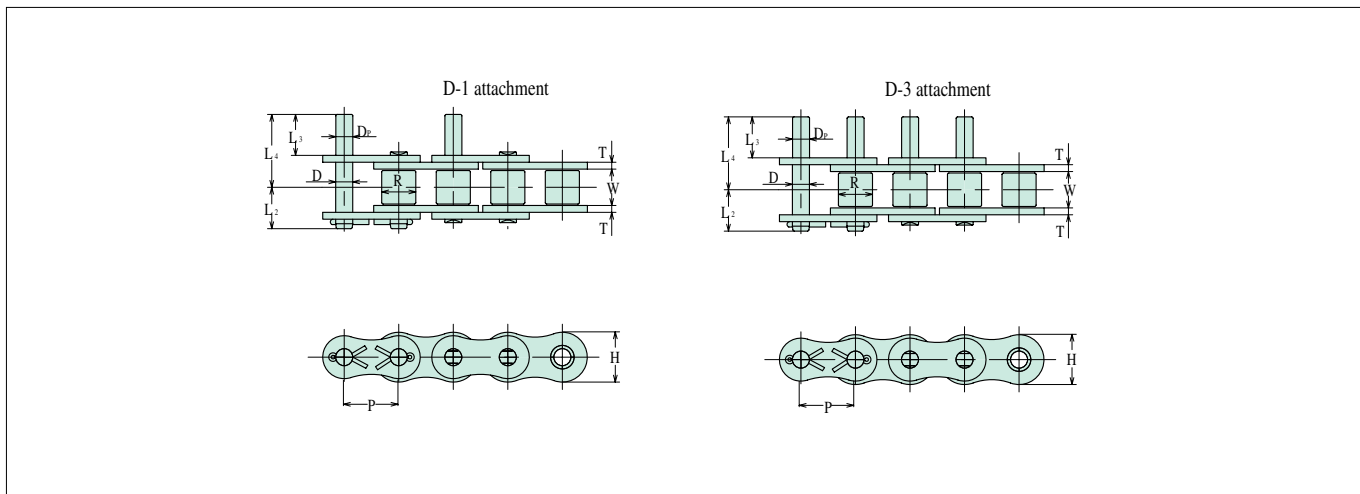

D-1, D-3 ATTACHMENT

Chain No.	Common Dimensions				Additional Weight	
	Dp	L3	L4	H	D-1	D-3
					g/pc	
35	3.58	9.50	14.70	9.00	0.80	1.60
40	3.96	9.50	16.80	11.70	1.00	2.00
50	5.08	11.90	21.00	14.60	2.00	4.00
60	5.95	14.30	25.90	17.50	3.00	6.00
80	7.93	19.10	33.90	23.40	7.00	14.00
100	9.53	23.80	41.90	29.30	12.00	24.00
120	11.10	28.60	51.40	35.10	20.00	40.00
140	12.70	33.30	57.50	40.90	30.00	60.00
160	14.28	38.10	67.40	46.70	45.00	90.00

Note: Refer to the standard roller chain for dimensions not stated here.

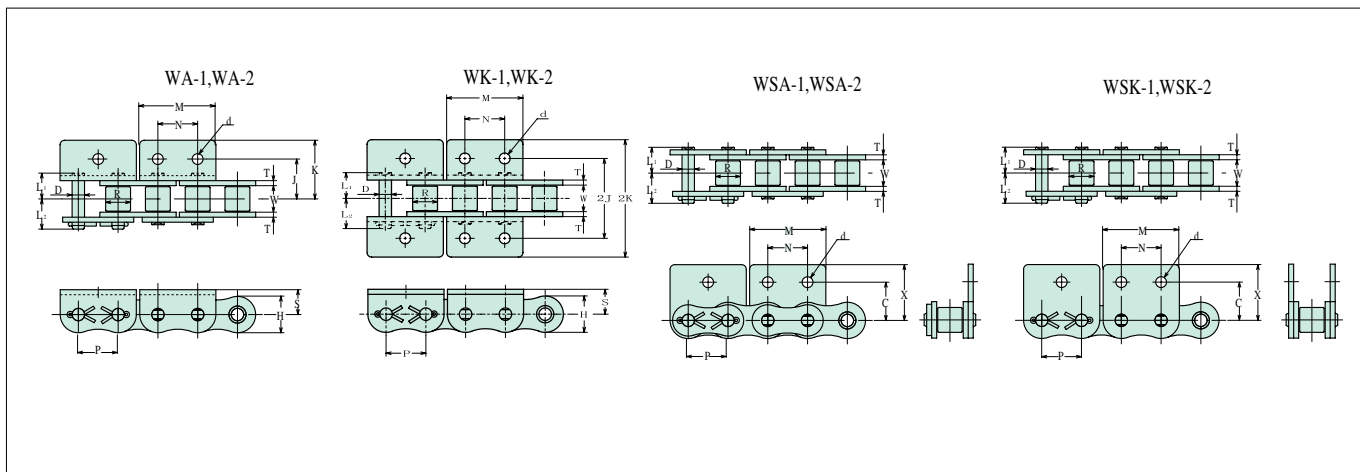

WA-1, WA-2, WK-1, WK-2, WSA-1, WSA-2, WSK-1, WSK-2 ATTACHMENT

Chain No.	Common Dimensions				Original Dimensions					
	M	d	N	S	WA		WK		WSA, WSK	
					J	K	2J	2K	C	X
40	24.30	3.60	12.70	7.90	12.70	17.30	25.40	34.60	12.70	17.30
50	30.40	5.20	15.90	10.30	15.90	23.30	31.80	46.60	15.90	23.10
60	36.50	5.20	19.10	11.90	19.10	28.10	38.10	56.20	18.30	27.10
80	48.60	6.80	25.40	15.90	25.40	35.90	50.80	71.80	24.60	34.50
100	61.00	8.80	31.80	19.80	31.80	44.30	63.60	88.60	31.80	43.00

Note: Refer to the standard roller chain for dimensions not stated here.

BS Standard Attachment Chains

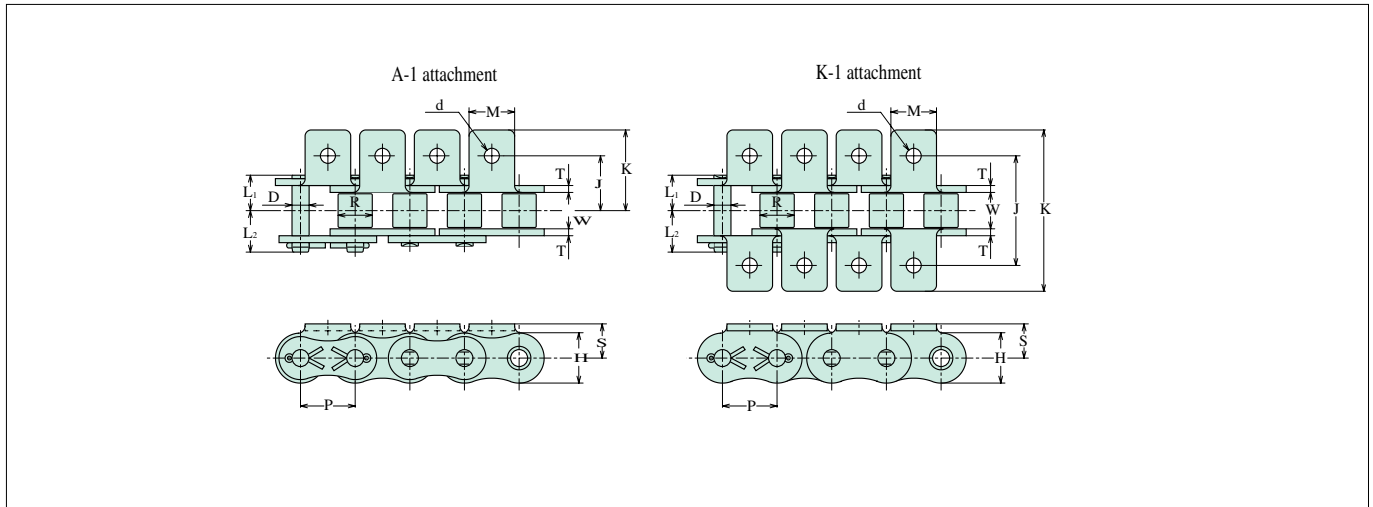

A-1, K-1 ATTACHMENT

Chain No.	Common Dimensions			Original Dimensions				Additional Weight	
	M	d	S	A-1		K-1		A-1	K-1
				J	K	2J	2K	g/pc	
08B	11.00	4.30	8.50	13.80	20.90	27.60	41.80	2.00	4.00
10B	14.00	5.30	10.50	15.80	24.20	31.60	48.40	3.20	6.40
12B	18.00	6.40	12.20	17.60	27.30	35.20	54.60	4.50	9.00
16B	24.00	8.40	17.00	29.00	41.90	58.00	83.80	20.00	40.00
20B	30.00	10.50	21.00	34.50	47.50	69.00	98.60	25.00	50.00

Note: Refer to the standard roller chain for dimensions not stated here.

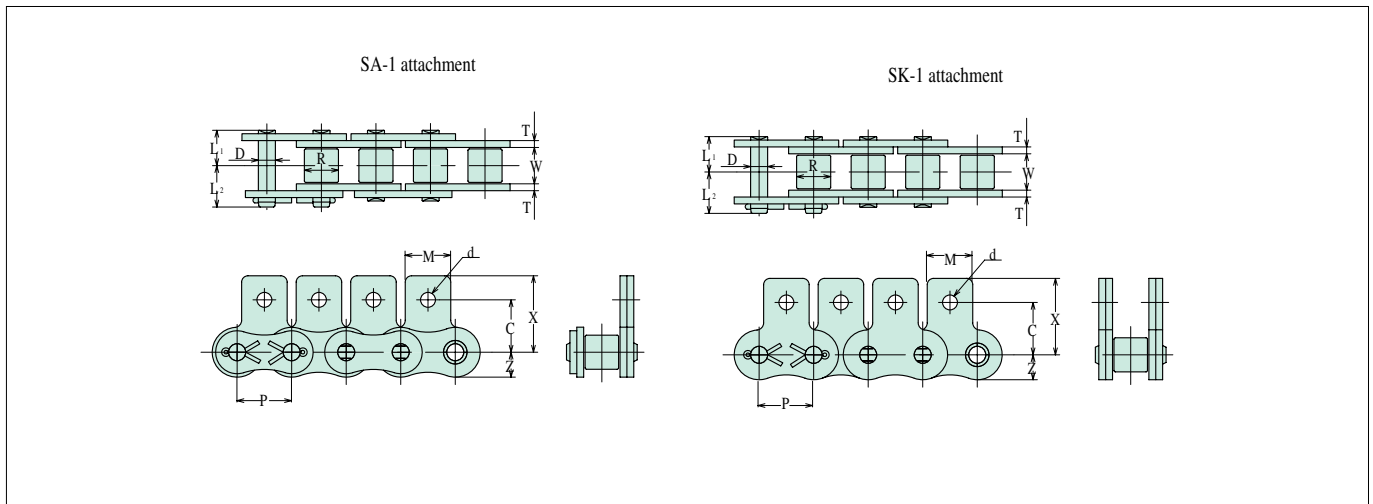

SA-1, SK-1 ATTACHMENT

Chain No.	Common Dimensions					Additional Weight	
	M	d	C	X	Z	SA-1	SK-1
						g/pc	
08B	11.00	4.30	13.70	20.80	5.90	2.00	4.00
10B	14.00	5.30	16.50	24.90	7.40	3.20	6.40
12B	18.00	6.40	18.50	28.10	8.10	4.50	9.00
16B	24.00	8.40	27.40	40.00	10.30	20.00	40.00
20B	30.00	10.50	33.00	47.50	13.20	25.00	50.00

Note: Refer to the standard roller chain for dimensions not stated here.

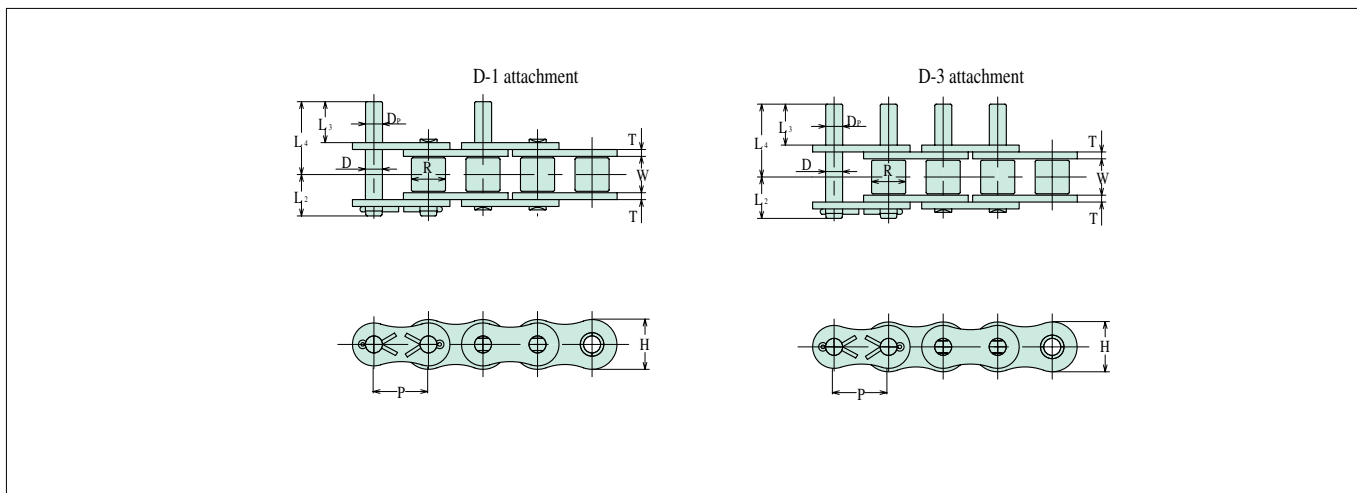

D-1, D-3 ATTACHMENT

Chain No.	Common Dimensions				Additional Weight	
	Dp	L3	L4	H	D-1	D-3
					g/pc	
08B	4.45	14.80	21.80	11.80	1.80	3.60
10B	5.08	17.60	25.90	14.70	2.80	5.60
12B	5.72	20.70	30.50	16.10	4.10	8.20
16B	8.26	33.30	49.30	20.60	14.00	28.00
20B	10.16	38.30	56.60	26.40	24.30	48.60

Note: Refer to the standard roller chain for dimensions not stated here.

Double Pitch Attachment Chains

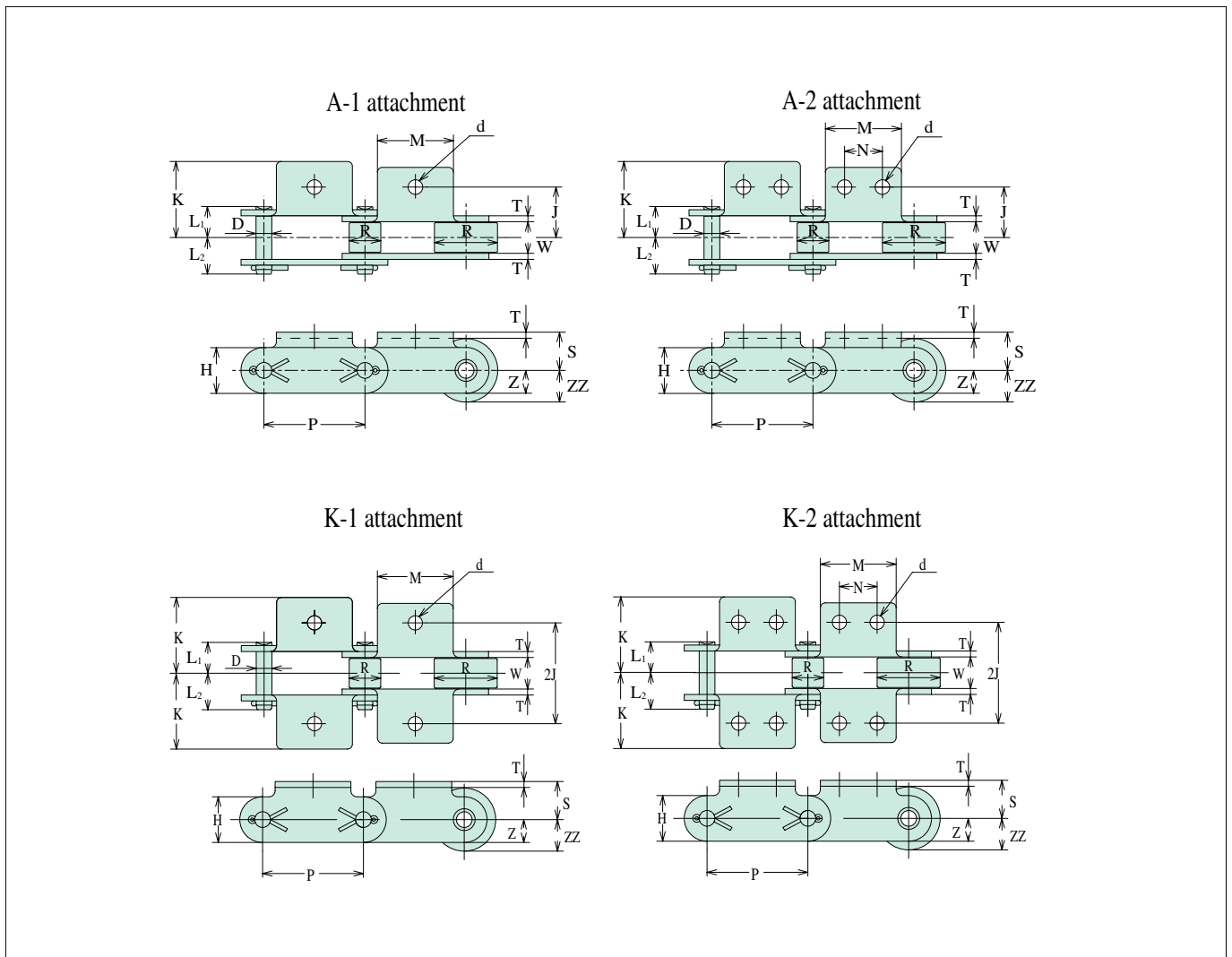

A-1, A-2, K-1, K-2 ATTACHMENT

Chain No.		Dimensions - mm								
Small Roller	Large Roller	M	d	N	S	Z	ZZ	A-1, A-2		K-1, K-2
								J	K	2J
C 2040	C 2042	19.10	3.60	9.50	9.10	5.70	—	12.70	19.10	25.40
							7.94			
C 2050	C 2052	23.80	5.20	11.90	11.10	7.50	—	15.90	24.20	31.80
							9.53			
C 2060H	C 2062H	28.60	5.20	14.30	14.70	8.50	—	21.40	31.20	42.80
							11.11			
C 2080H	C 2082H	38.10	6.80	19.10	19.10	11.30	—	27.80	40.60	55.60
							14.29			
C 2100H	C 2102H	47.60	8.80	23.80	23.40	14.30	—	33.30	50.00	66.60
							19.84			
C 2120H	C 2122H	57.20	10.50	28.60	27.80	17.40	—	39.70	61.90	79.40
							22.22			
C 2160H	C 2162H	76.20	14.00	38.10	36.50	23.80	—	52.40	76.10	104.80
							28.58			

Note: Refer to the standard roller chain for dimensions not stated here.

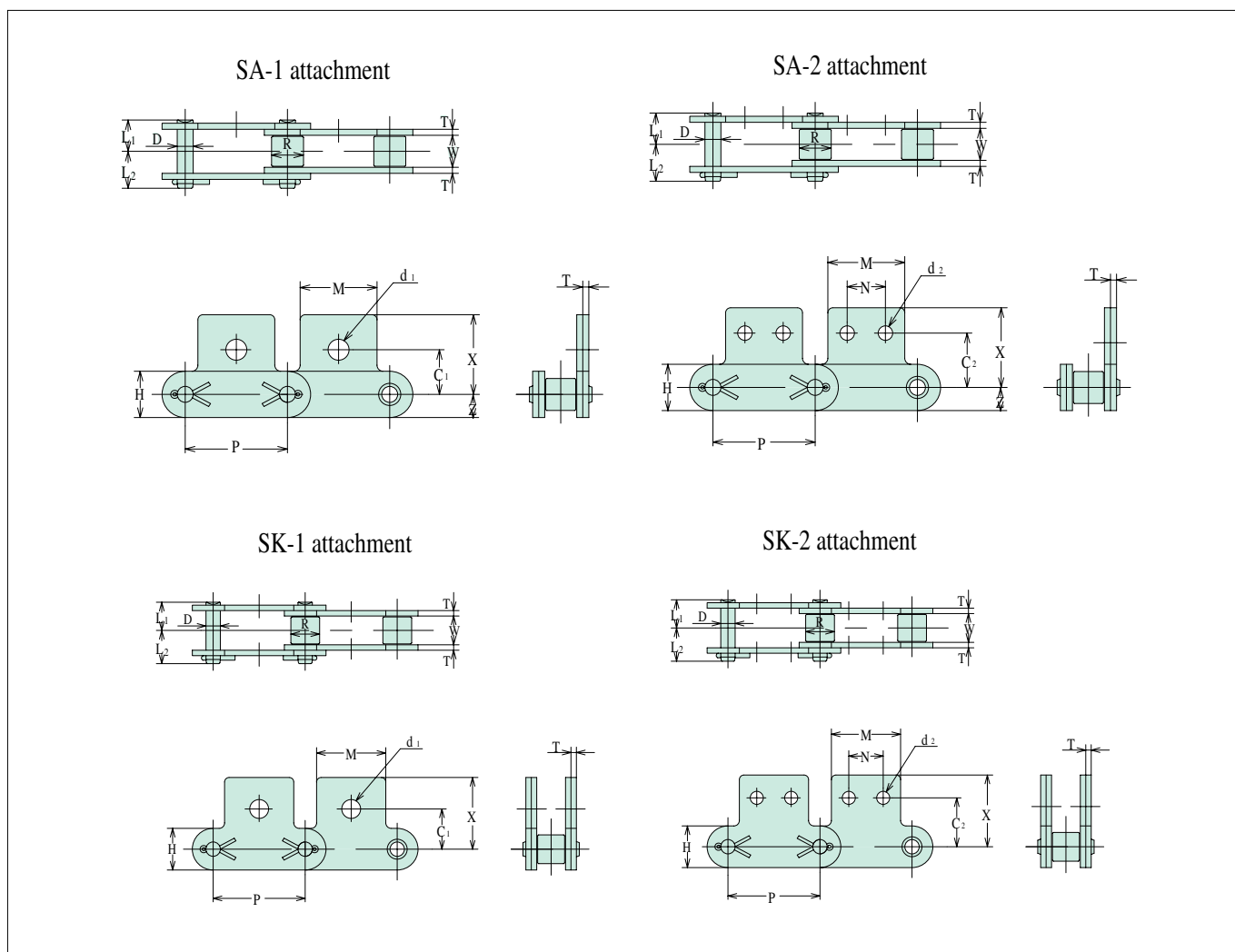

SA-1,SA-2,SK-1,SK-2 ATTACHMENT

Chain No.		Dimensions - mm								
Small Roller	Large Roller	M	X	Z	ZZ	SA-1, SK-1		SA-2, SK-2		
						C1	d1	C2	d2	N
C 2040	C 2042	19.10	19.80	5.70	—	11.10	5.20	13.50	3.60	9.50
					7.94					
C 2050	C 2052	23.80	24.60	7.50	—	14.30	6.80	15.90	5.20	11.90
					9.53					
C 2060H	C 2062H	28.60	30.60	8.50	—	17.50	8.80	19.10	5.20	14.30
					11.11					
C 2080H	C 2082H	38.10	40.20	11.30	—	22.20	10.50	25.40	6.80	19.10
					14.29					
C 2100H	C 2102H	47.60	50.30	14.30	—	28.60	14.00	31.80	8.80	23.80
					19.84					
C 2120H	C 2122H	57.20	61.10	17.40	—	33.30	16.00	37.30	10.50	28.60
					22.22					
C 2160H	C 2162H	76.20	76.20	23.80	—	44.50	21.00	50.80	14.00	38.10
					28.58					

Note: Refer to the standard roller chain for dimensions not stated here.

Double Pitch Attachment Chains

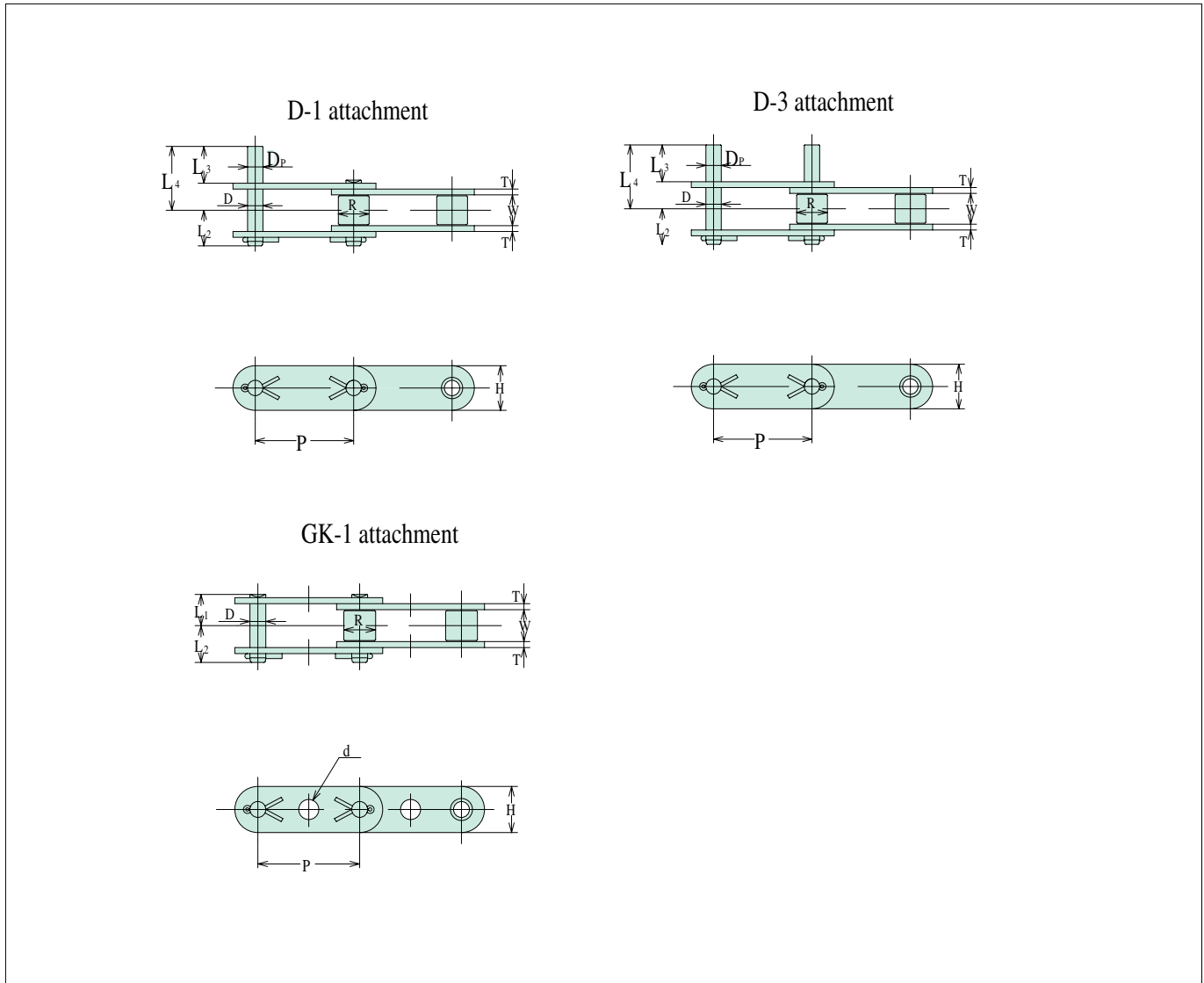

D-1, D-3, GK-1 ATTACHMENT

Chain No.		Dimensions - mm				Additional Weight	
Small Roller	Large Roller	D-1, D-3			GK-1	D-1	D-3
		Dp	L3	L4	d	g/pc	
C 2040	C 2042	3.96	9.50	16.80	4.10	0.90	1.80
C 2050	C 2052	5.08	11.90	21.10	6.40	1.80	3.60
C 2060H	C 2062H	5.95	14.30	27.50	6.40	3.00	6.00
C 2080H	C 2082H	7.93	19.10	35.60	8.10	7.00	14.00
C 2100H	C 2102H	9.53	23.80	43.20	10.10	12.00	24.00
C 2120H	C 2122H	11.10	28.60	53.00	12.10	20.00	40.00
C 2160H	C 2162H	14.28	38.10	69.00	—	44.00	88.00

Note: Refer to the standard roller chain for dimensions not stated here.

Chains with Top Rollers

These chains have rollers attached in the top center of the chain pitch, so that goods can be placed directly onto the top roller.

The chain can move continuously while freight is stored, or it can be stopped temporarily.

The top rollers can also be made of plastic.

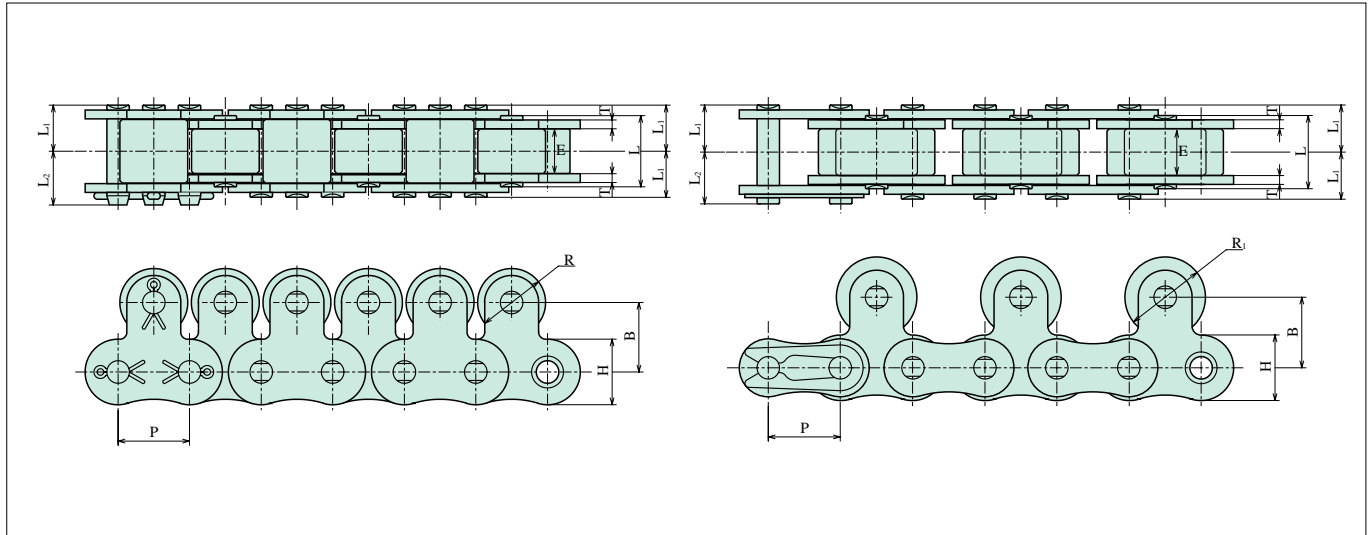

Chain No.	Dimensions - mm									Average Ultimate Strength kN	Average Chain Weight kg/m
	Pitch P	Top-Roller			Pin		Link Plate		Position B		
		Dia.		Width	Length		Height	Thickness			
		R	R1	E	L1	L2	H	T			
40	12.70	11.00	15.88	7.95	8.20	9.10	11.70	1.50	12.70	19.10	1.10
50	15.875	15.00	19.05	9.53	10.30	11.60	14.60	2.00	15.90	31.90	1.61
60	19.05	18.00	22.23	12.70	12.70	13.90	17.50	2.40	18.30	43.10	2.80
80	25.40	24.00	28.58	15.88	16.20	18.80	23.40	3.20	24.60	78.50	4.60
100	31.75	30.00	39.67	19.10	19.60	23.20	29.30	4.00	31.80	118.00	7.60
C2040	25.40	—	15.88	7.95	8.20	10.30	11.40	1.50	15.00	19.10	1.29
C2050	31.75	—	19.05	9.53	10.30	11.60	15.00	2.00	19.00	31.90	1.99
C2060H	38.10	—	22.23	12.70	14.40	16.70	17.00	3.20	23.00	54.90	3.50
C2080H	50.80	—	28.58	15.88	17.80	21.10	22.60	4.00	29.00	90.20	5.30

Note: Refer to the standard roller chain or the double pitch conveyor roller chain for dimensions not stated here.

Side Roller Chains

These chains have side rollers built onto one or both sides, in parallel or staggered patterns. The side rollers make the chains run extraordinarily smoothly. Use of plastic side rollers reduces noise.

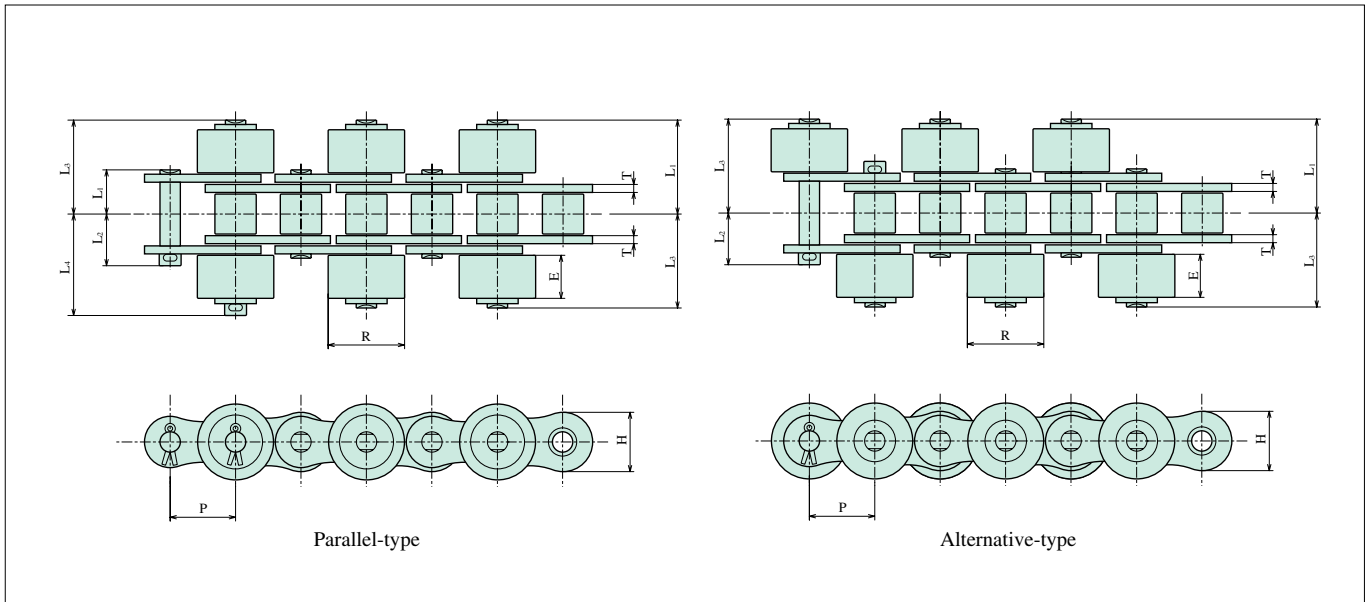

Chain No.	Dimensions - mm									Average Chain Weight kg/m
	Pitch	Side-Roller		Pin				Link Plate		
		Dia.	Width	Length				Height	Thick.	
				L1	L2	L3	L4			
40	12.70	15.88	7.60	8.20	10.30	17.30	19.10	11.60	1.50	0.86
50	15.875	19.05	9.20	10.30	11.60	21.40	23.10	14.50	2.00	1.40
60	19.05	22.23	12.50	12.70	14.90	27.90	30.00	17.40	2.40	1.93
80	25.40	28.58	15.60	16.20	18.80	34.80	37.80	23.40	3.20	3.30
100	31.75	39.67	18.50	19.60	23.20	41.90	45.50	29.30	4.00	5.56
C2040	25.40	15.88	7.60	8.20	10.30	17.30	19.10	11.50	1.50	0.61
C2042		23.00						11.50	1.50	1.20
C2050	31.75	19.05	9.20	10.30	11.60	21.40	23.10	15.00	2.00	1.01
C2052		27.00						15.00	2.00	1.65
C2060H	38.10	22.23	12.50	14.40	16.70	29.50	31.60	17.00	3.20	1.65
C2062H		30.00						17.00	3.20	2.60
C2080H	50.80	28.58	15.60	17.80	21.10	36.50	39.50	22.80	4.00	2.74

Note: Refer to the standard roller chain or the double pitch conveyor roller chain for dimensions not stated here.

Trouble Shooting Hints

The below chart shows the most common chain failures and causes, but not necessarily the only ones.

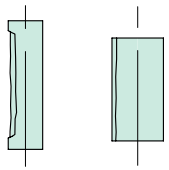
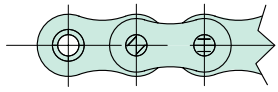
Problem	Possible Causes of Problem	Suggested Remedy
 <p>Pin or Bushing Galling</p>	<ul style="list-style-type: none"> • Overload • Inadequate lubrication 	<ul style="list-style-type: none"> • Properly lubrication • Replace chain when elongation exceed functional limits
 <p>Turned Pins</p>	<ul style="list-style-type: none"> • Overload • Inadequate lubrication 	<ul style="list-style-type: none"> • Replace chain as soon as possible
Excessive Noise	<ul style="list-style-type: none"> • Too little or too much slack • Chain obstruction • Loose chain guard or bearing 	<ul style="list-style-type: none"> • Adjust centers or take-up • Inspect & remove obstruction • Tighten bolts and check bearings
Chain Vibration	<ul style="list-style-type: none"> • Excessive chain slack • Center distance too long • stiff links 	<ul style="list-style-type: none"> • Adjust chain tensioner • Install idler • Lubricate or replace chain
Wear on inside of link plate and one side of sprocket teeth	<ul style="list-style-type: none"> • Misalignment 	<ul style="list-style-type: none"> • Realign sprockets and shafts • Replace chain and sprockets if necessary
Chain stiffens	<ul style="list-style-type: none"> • Excessive load • Misalignment • Inadequate lubrication • Corrosion 	<ul style="list-style-type: none"> • Replace chain with one of suitable strength • Inspect alignment • Clean and establish correct lubrication • Replace with corrosion resistant chain
Chain Climbs Sprockets	<ul style="list-style-type: none"> • Excessive chain wear • Excessive chain slack • Inadequate lubrication • Sprocket tooth wear 	<ul style="list-style-type: none"> • Replace chain • Install tensioner if necessary • Replace sprocket

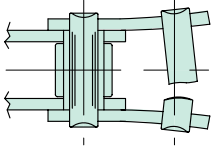
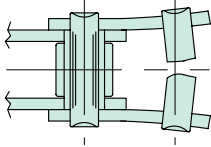
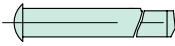
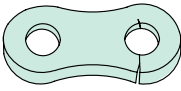
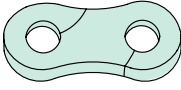
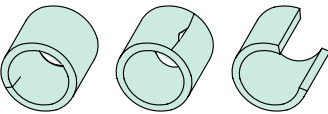
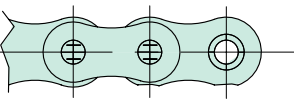
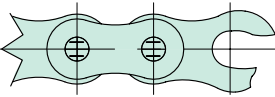
Problem	Possible Causes of Problem	Suggested Remedy
 <p>Broken Pins</p>	<ul style="list-style-type: none"> • Extreme overload 	<ul style="list-style-type: none"> • Inspect the drive to determine the cause of high load • Redesign drive using a higher capacity chain
 <p>Broken Pins (center)</p>	<ul style="list-style-type: none"> • Loading is greater than pins dynamic capacity 	<ul style="list-style-type: none"> • Inspect the drive to determine the cause of high load • Redesign drive using a higher capacity chain
 <p>Broken Offset Links Pins</p>	<ul style="list-style-type: none"> • Overload 	<ul style="list-style-type: none"> • Onepitch offsetlinks are not recommended • Redesign drive using a higher capacity chain
 <p>Fatigue Failure</p>	<ul style="list-style-type: none"> • Loading is greater than chain's dynamic capacity 	<ul style="list-style-type: none"> • Inspect the drive to determine the cause of high load • Redesign drive using a higher capacity chain
 <p>Cracking</p>	<ul style="list-style-type: none"> • Stress corrosion cracking 	<ul style="list-style-type: none"> • Protect the chain from corrosion • Install anti-corrosive chains
 <p>Broken Rollers</p>	<ul style="list-style-type: none"> • Foreign material between chain and sprocket tooth • Fatigue failure 	<ul style="list-style-type: none"> • Redesign chain speed and load • Shield drive from foreign matter
 <p>Worn Plates</p>	<ul style="list-style-type: none"> • Bottom of plates worn due to rubbing on guides. 	<ul style="list-style-type: none"> • Chain should be replaced when wear becomes over 5% of the plates height
 <p>Fractured Plate</p>	<ul style="list-style-type: none"> • Extreme overload 	<ul style="list-style-type: none"> • Inspect the drive to determine the cause of high load • Redesign drive using a higher capacity chain

Selection of Transmission Roller Chains

Coefficients Relevant to Selection

Tables 1 through 5 present the coefficients that are relevant to the selection of chains. All values assume smooth operation, and for this reason, they are not suitable for special operating conditions.

Service Coefficient

The transmission performance of chains requires smooth operation for full realization; accordingly, correction will need to be carried out for loading conditions. The service coefficients from the following table are to be used at this time.

Table 1: Service Condition α_U

Type of loading	Motor type Typical applications	Motor	Internal combustion	
			Fluid combustion	No fluid combustion
Even	Pumps, blowers, generators, mixers, conveyors. Belts with little load variation.	1.00	1.00	1.20
Slight shock	Standard machinery, compressors, automatic furnaces, dryers. Conveyors with small amounts of variation.	1.30	1.20	1.40
Large shock	Crushers, compressors, press equipment, mixers, civil engineering machinery	1.50	1.40	1.70

Multiplex Coefficient

The transmission performance of multiplex chains is determined by applying the multiplex coefficient from the following table to the transmission performance for a single chain.

Table 3: Multiplex Coefficient α_L

Multiplicity	Multiplex coefficient
2	1.30
3	1.90
4	2.50

CAUTION

The multiplex performance cannot be achieved by simply multiplying the single-chain performance by the multiplicity.

Unbalanced Load Coefficient

When using two or four chains in a suspension situation or the like, the load applied to chains does not conform to an average value. For this reason, the unbalanced load coefficient from the following table is to be used to determine the load for each chain.

Table 5: Unbalanced Load Coefficient α_B

Suspensions	Unbalanced load coefficient
2	0.60
4	0.35

Speed Coefficient

As the travel speed of a chain increases, operating conditions become more severe; consequently, the speed coefficient from the following table is used to indicate this severity.

Table 2: Speed Coefficient α_v

Chain speed	Speed coefficient
~15m/min	1.00
15~30m/min	1.20
30~50m/min	1.40

Safety Coefficient

The safety coefficient (or safety factor, SF) is determined using the formula shown below, and it should generally be maintained within the 7 to 10 range. However, it is often necessary to raise the safety coefficient for certain usage conditions (i.e., chain speed, ambient temperature, loading method, etc.). Furthermore, any legal requirements must also be implemented at this time.

$$SF = \frac{\text{Tensile strength}}{\text{Tensile force in chain (maximum applied load)}}$$

Table 4: Safety Coefficient (SF)

Chain speed	Safety coefficient
~25m/min	7.00
25~50m/min	8.00

Example: Load W_1 kgf applied to one of four chains used to suspend an object of weight $W = 3,000$ kgf.

$$\begin{aligned} W_1 &= W \times \alpha_B \\ &= 3000 \times 0.35 \\ &= 1050 \text{ (kgf)} \end{aligned}$$

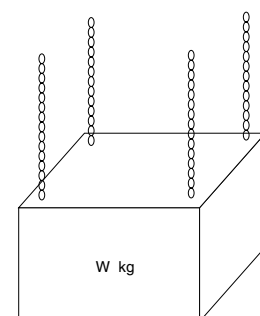

Selection Formulae

Chain Length: L (no. of links)

$$L = \frac{N_1 + N_2}{2} + 2 \cdot C_p + \frac{(N_2 - N_1)^2}{40 \cdot C_p}$$

where C_p is the inter-shaft distance expressed as a pitch;
 N_1 is the number of teeth on the small sprocket; and
 N_2 is the number of teeth on the large sprocket.

Chain Speed: v (m/min)

$$v = \frac{p \cdot N \cdot r}{1000}$$

where p is the chain pitch (mm);
 N is the number of teeth on the sprocket; and
 r is the sprocket speed (rpm).

Chain Tensile Force for Rated Output: F (kgf)

$$F = \frac{6120 \cdot kW}{v}$$

where kW is the rated output (kW) and
 v is the chain speed (m/min).

Corrected Transmission Performance: kW' (kW)

$$kW' = \alpha_u \cdot kW$$

where kW is the rated output (kW) and
 (α_u) is the service coefficient (from Table 1 on page 65).

CAUTION

The chain length L found using the formula presented here should be rounded off to an integer. Note that an offset link will be required when the chain length is an odd number; however, the tooth numbers and inter-shaft distance should be adjusted whenever possible to ensure that calculation produces an even number.

Simple Selection Tables

Mode of Use

These tables allow you to select usable chains based on the small sprocket speed and the transmission performance (corrected).

Example: Selection based on a sprocket speed of 500 rpm and a transmission performance of 5 kW.

(1) Tentatively set the number of teeth on the small sprocket. Here, a value of $N = 15$ will be used.

Chain number (No.)	Number of teeth	Multiplicity	Speed coefficient
60	15	1	Suitable
50	15	2	Not economic
50	17	1	No reserve in terms of performance

(2) The intersection of small-sprocket speed (horizontal axis) and transmission performance (vertical axis) on the Simple Selection Table for 15 gear teeth appears between No. 50 and No. 60; accordingly, No. 60 is selected.

(3) Evaluate situations for other tooth numbers in the same way, and select a suitable combination of tooth number and chain specification.

CAUTION

Selection of chains from the right side of the triangular sections on the Simple Selection Tables should be avoided whenever possible.

Standard Roller Chains

Number of teeth = 15

A,B
 C
 D
 (Refer to page 70 for the lubricated types.)

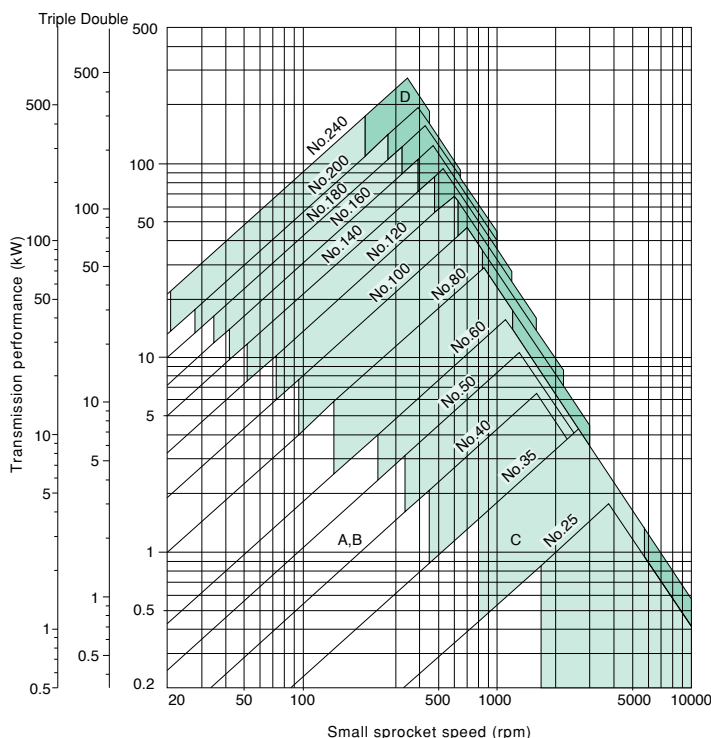

Chain number (No.)	Pitch circle diameter (mm)	Outer diameter (mm)
25	30.54	34.00
35	45.81	51.00
40	61.08	67.00
50	76.35	84.00
60	91.62	101.00
80	122.17	135.00
100	152.71	168.00
120	183.25	202.00
140	213.79	236.00
160	244.33	269.00
180	274.87	303.00
200	305.42	337.00
240	366.50	404.00

Number of teeth = 17

A,B
 C
 D
 (Refer to page 70 for the lubricated types.)

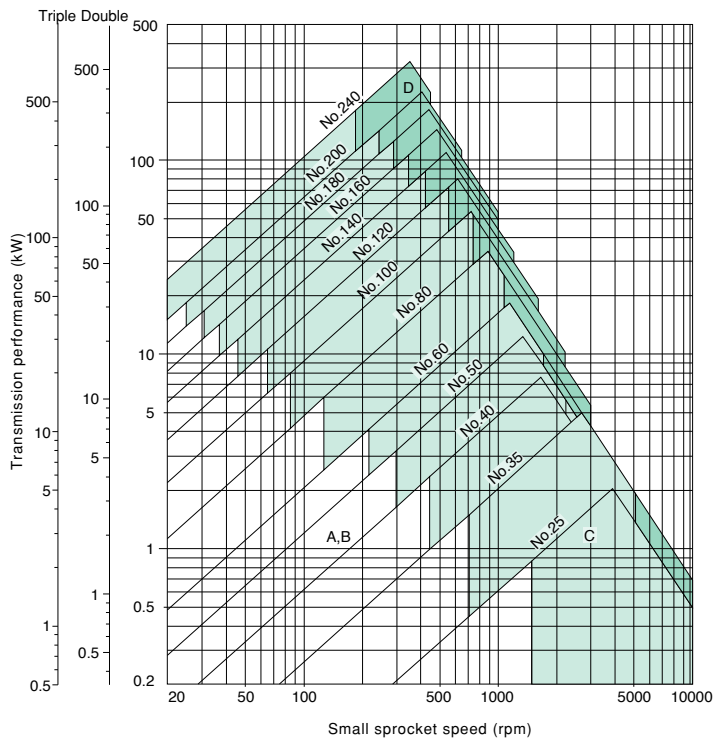

Chain number (No.)	Pitch circle diameter (mm)	Outer diameter (mm)
25	34.56	38.00
35	51.84	57.00
40	69.12	76.00
50	86.39	94.00
60	103.67	113.00
80	138.23	151.00
100	172.79	189.00
120	207.35	227.00
140	241.91	264.00
160	276.46	302.00
180	311.02	340.00
200	345.58	378.00
240	414.70	453.00

Number of teeth = 19

A,B
 C
 D
 (Refer to page 70 for the lubricated types.)

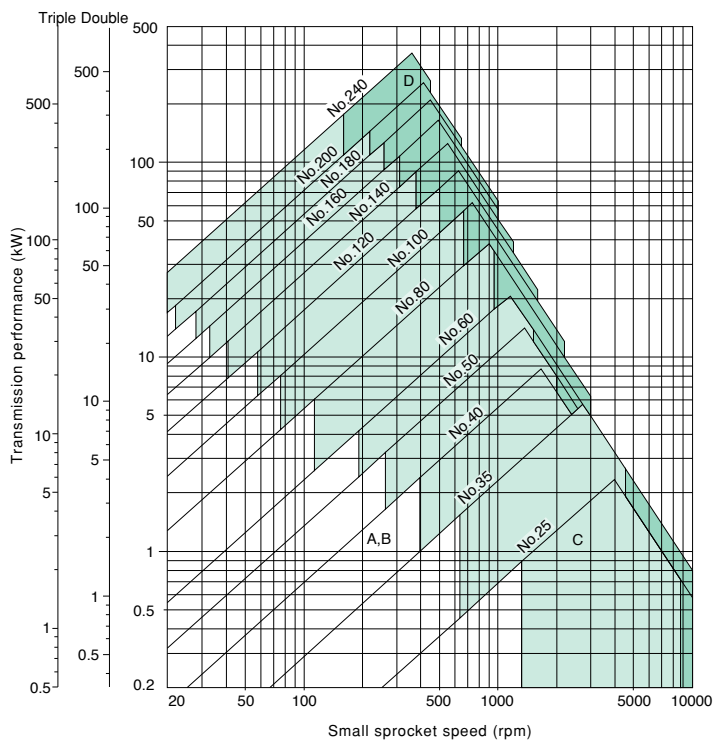

Chain number (No.)	Pitch circle diameter (mm)	Outer diameter (mm)
25	38.58	42.00
35	57.87	63.00
40	77.16	84.00
50	96.45	105.00
60	115.74	126.00
80	154.32	167.00
100	192.90	209.00
120	231.48	251.00
140	270.06	293.00
160	308.64	335.00
180	324.12	358.00
200	385.79	419.00
240	462.95	502.00

Number of teeth = 21

A,B
 C
 D
 (Refer to page 70 for the lubricated types.)

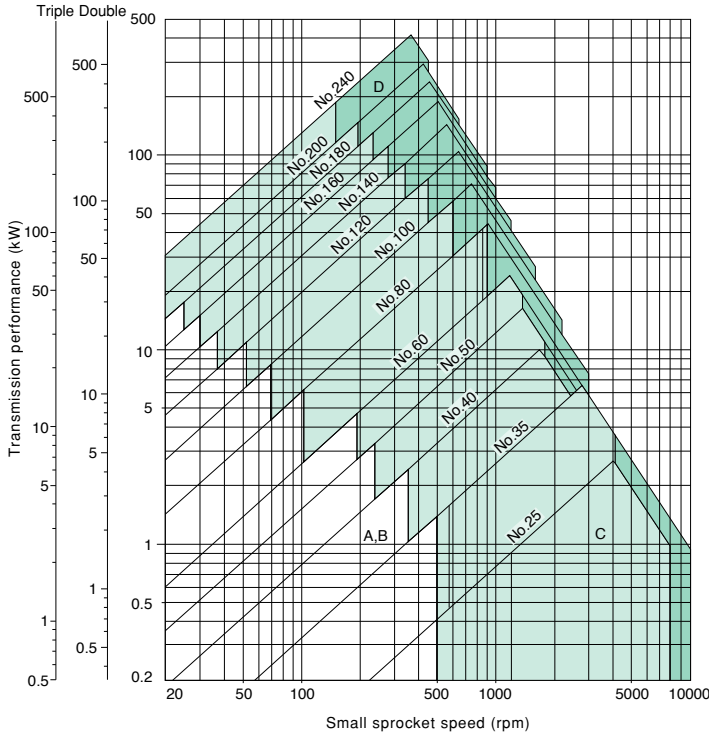

Chain number (No.)	Pitch circle diameter (mm)	Outer diameter (mm)
25	42.61	46.00
35	63.91	69.00
40	85.21	92.00
50	106.51	115.00
60	127.82	138.00
80	170.42	184.00
100	213.03	230.00
120	255.63	276.00
140	298.24	322.00
160	340.84	368.00
180	383.45	413.00
200	426.05	459.00
240	511.26	551.00

Number of teeth = 23

A,B
 C
 D
 (Refer to page 70 for the lubricated types.)

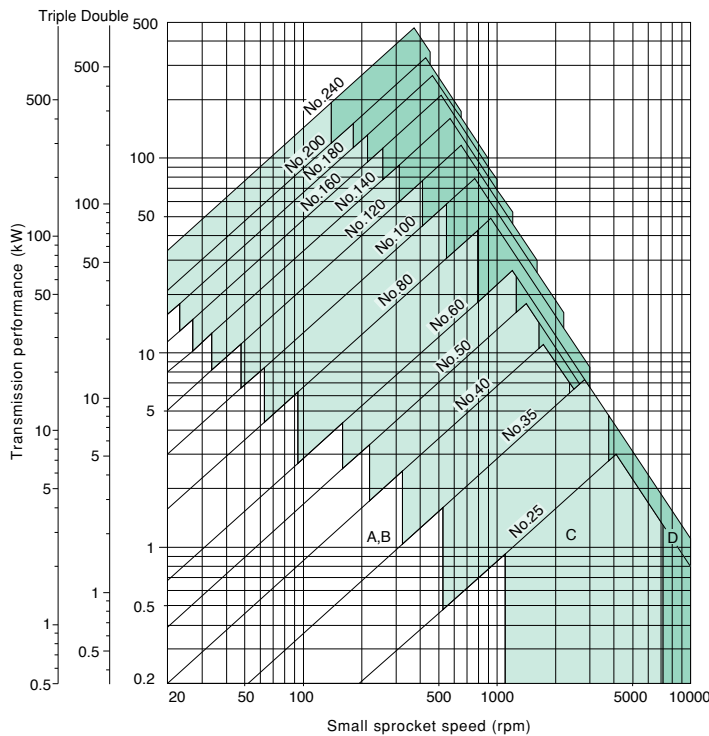

Chain number (No.)	Pitch circle diameter (mm)	Outer diameter (mm)
25	46.63	50.00
35	69.95	75.00
40	93.27	100.00
50	116.58	125.00
60	139.90	150.00
80	186.54	200.00
100	233.17	250.00
120	279.80	300.00
140	326.44	350.00
160	373.07	400.00
180	419.71	450.00
200	466.34	500.00
240	559.61	600.00

SUPER ROLLER CHAINS

Number of teeth = 15

B
 C
 D
 (Refer to page 70 for the lubricated types.)

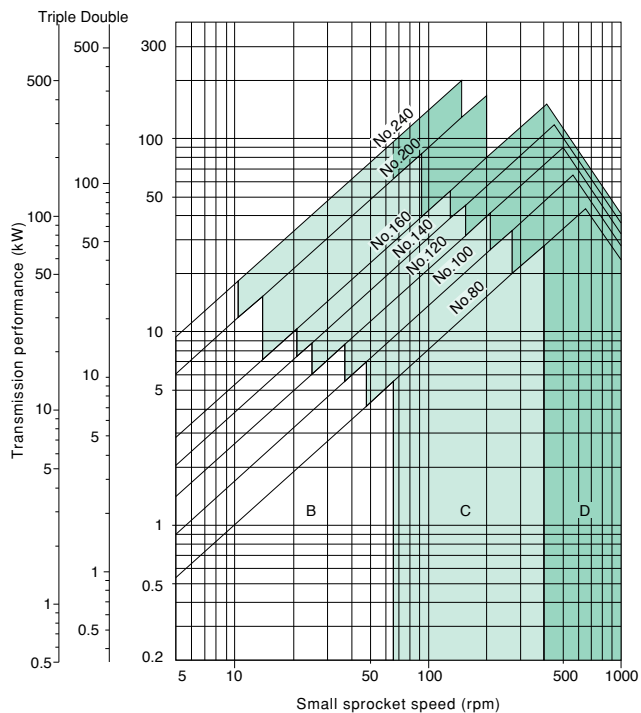

Chain number (No.)	Pitch circle diameter (mm)	Outer diameter (mm)
80	122.17	135.00
100	152.71	168.00
120	183.25	202.00
140	213.79	236.00
160	244.33	269.00
200	305.42	337.00
240	366.50	404.00

Number of teeth = 17

B
 C
 D
 (Refer to page 70 for the lubricated types.)

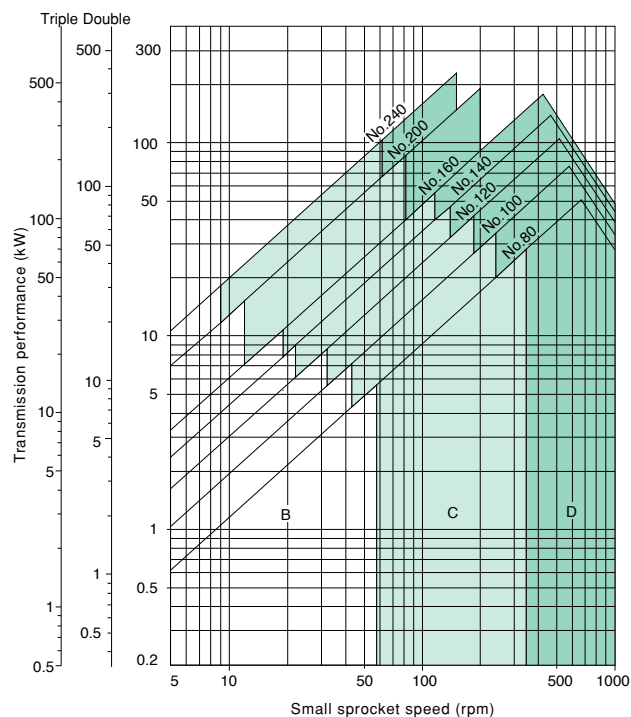

Chain number (No.)	Pitch circle diameter (mm)	Outer diameter (mm)
80	138.23	151.00
100	172.79	189.00
120	207.35	227.00
140	241.91	264.00
160	276.46	302.00
200	345.58	378.00
240	414.70	453.00

Number of teeth = 19

B
 C
 D
 (Refer to page 70 for the lubricated types.)

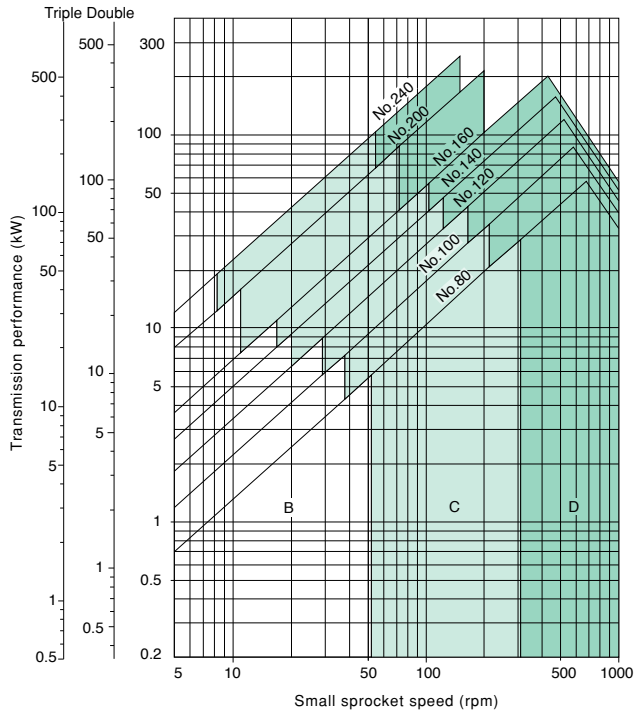

Chain number (No.)	Pitch circle diameter (mm)	Outer diameter (mm)
80	154.32	167.00
100	192.90	209.00
120	231.48	251.00
140	270.06	293.00
160	308.64	335.00
200	385.79	419.00
240	462.95	502.00

Number of teeth = 21

B
 C
 D
 (Refer to page 70 for the lubricated types.)

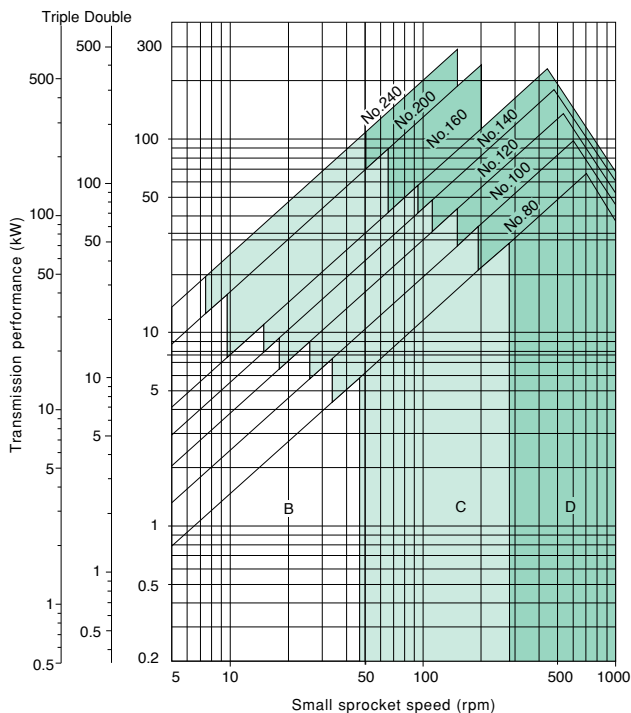

Chain number (No.)	Pitch circle diameter (mm)	Outer diameter (mm)
80	170.42	184.00
100	213.03	230.00
120	255.63	276.00
140	298.24	322.00
160	340.84	368.00
200	426.05	459.00
240	511.26	551.00

INSTALLATION AND ARRANGEMENT

To design excellent chain drives, chains and sprockets should be properly arranged and installed.

CENTER DISTANCE AND CHAIN LAP

Chain lap on the small sprocket must be at least 120 degrees.

Sprockets can be spaced at any distance as long as their teeth do not touch. Optimum distance is 30 to 50 times of pitch of the chain used except when there is a pulsating load. In case of pulsating drive, distance of less than 20 chain pitches is adequate.

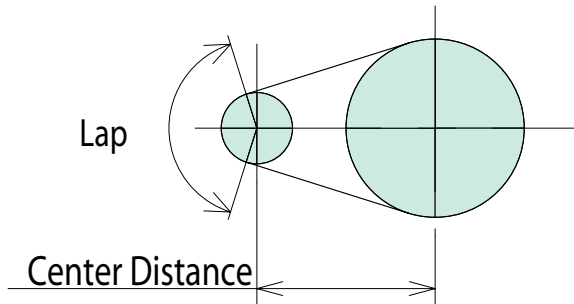

TENSION AND SLACK

Proper amount of chain tension should be maintained. Inadequate tension will step up wear, while excessive sag will result in pulsating impact, stranding and breakage.

Adequate slack is 4% of the span for normal drives. In the following cases, the slack should be about 2% of the span.

- 1) Vertical position or near to vertical position.
- 2) Center distance exceeding 1 meter.
- 3) Heavy load application with frequent starts and stops.
- 4) Application with sudden reverse motions.

DRIVE POSITIONS

<Horizontal>

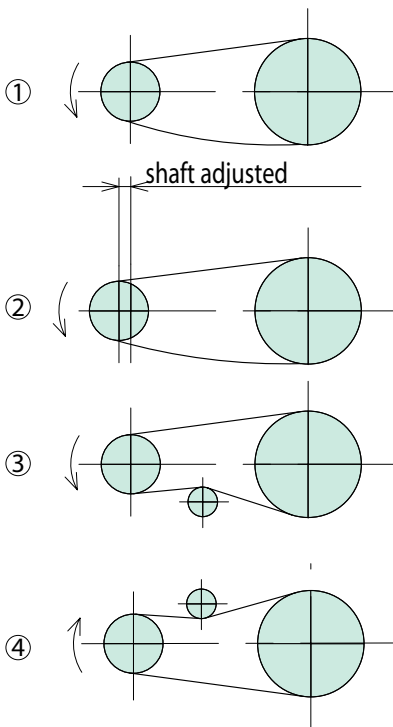

Horizontal arrangements

- ① Generally roller chain slack is on the lower side.
- ② When the center distance is short chain slack is adjusted by expanding it.
- ③ When the center distance is long, chain slack is adjusted by installing a tightener.
- ④ When chain slacks on the upper side, adjust it by a tightener.

<Inclined and Vertical>

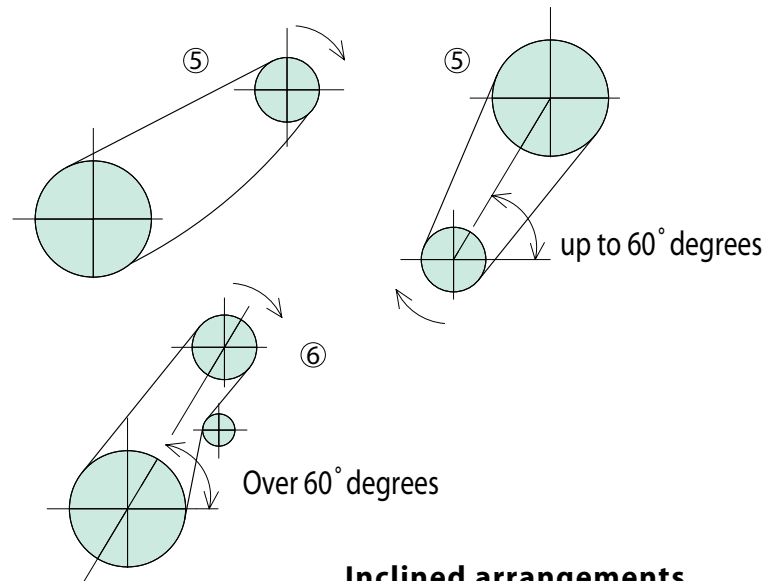

Inclined arrangements

- ⑤ Inclined operation should be within 60° , possible.
- ⑥ Too much slack will cause chain to ride up on the lower sprocket or come off. It should be adjusted by a tightener.

Vertical arrangements

- ⑦, ⑧ Excessive chain sag should be automatically adjusted by a tightener. It is mandatory when the driving shaft (small sprocket) is placed on the bottom side.

LUBRICATION

Proper lubrication of roller chains is a very important factor in getting their best possible performance and longer lifetime. No matter how well a transmission system is designed, if it is not properly lubricated, its service life will be shortened.

Abrasion between the pin and bushing causes roller chains to stretch. Therefore, these parts should be well lubricated.

The gap between the pin-link plate and roller-link plate on the slack side of the chain should be filled with lubricant.

The oil forms a film which minimizes wear of the pin and bushing thus increasing the chain service life.

It also reduces noises and cools down the chain running at high speed.

POINTS OF LUBRICATION

- 1) Fill and change oil periodically.
- 2) Generally, heavy oil and grease are not suitable as a lubricant.
- 3) Avoid mix of oil with another kind or other maker's.
- 4) Adequate lubrication quantity is also essential for a chain's longer service life.

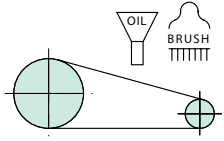
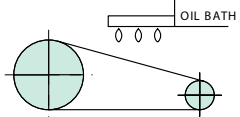
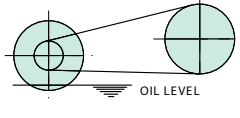
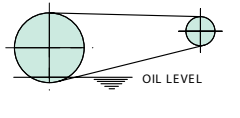
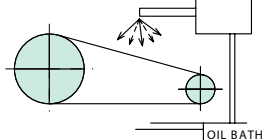
TYPE	Method	Explanation	
A	Manual Lubrication	Regular application by brush or spout can	
B	Dripping Lubrication	Rapid drip(20 drops of oil per minute) using a lubricator	
C	Disc Lubrication	Lubrication by a disc fitted to the sprocket shaft	
	Oil Bath Lubrication	Part of the chain passes through oil provided in a sealed casing	
D	Forced Lubrication	Oil provided in a leakproof casing is circulated by a pump to provide forced-feed lubrication	

Recommended Grade of Oil

Chain No.	Temperature[°C]							
	-10	0	40	50	-10	0	40	50
	0	40	50	60	0	40	50	60
Lubrication Type	TYPE A,B,C				TYPE D			
~ 50	SAE10	SAE20	SAE30	SAE50	SAE10	SAE20	SAE30	SAE40
60 ~ 80	20	30	40	50	10	20	30	40
100	20	30	40	50	20	30	40	50
120 ~	30	40	50	50	20	30	40	50



**If misselected, misinstalled and missafe-guard Chain will break and serious injury or property damage can result.
Please read an instruction manual carefully before installation.**

Roller Chain Application Information

Please select the chain(compare with Technical Data)when you use.

If the chain abused through improper installation, operating or maintenance procedures, failure can lead to personal injury or property damage.

Ultimate Tensile Strength

Ultimate tensile strength is the one time pull required to break the chain therefore these are not the allowable working load.

Safety factor must be considered when selecting roller chain.

A roller chain should never be loaded above 50% of Ultimate strength for even one cycle.

When to use a multiple-strand roller chain, please consider the multiple-strand factor.

Guarding

The chain can break in normal service due to the effects of wear, fatigue or unexpected overloads. Therefore a roller chain drive should have adequate guarding to prevent personal injury or property damage.

Connecting Link

When a slip-fit connecting link coverside for ease of assembly is used, a chain's working capacity is reduced as much as 20% on some models. ZEXUS offered New Connecting Links with slip-fit coverside as strong as the base chain Recommend this New Connecting Link to use.

Offset Link

One-pitch offset links are very handy, pin and offset linkplates have to be slip-fitted.

It's allowable working load is approximately 30% less.

Therefore one-pitch offset links are not recommended especially frequent, impact load demand high speed driving.

Cotter Pin, Spring Clip

Keep angle 90% approx. to spread out prongs of cotter pin. Do not reuse the cotter and do not use the commercial cotters on the market.

Be sure to insert spring clip properly into and seat in the groove on the end to Pin after installation of Connecting Link cover plate onto pins, and do not spring one leg of the clip over the pin end to avoid breakdown of the leg.

Do not spread out clip's legs too much to prevent falling spring clip off and unexpected accident.

Install spring clips with solid end pointing in the direction of chain travel.

Rust Corrosion

If a chain is corroded, its capacity is reduced. If corrosion is severe, the link plates may crack even though the chain is not under load.

In view this, carbon steel chain should not be exposed to corrosive conditions, acid fumes, salt spray sea water.

Chain corrosion from normal atmospheric conditions may be minimized by proper lubrication.

CAUTION

- 1) Always lock out machinery power switch before attempting removal, installation, or any servicing of chain.
- 2) Wear eye and face protection when grinding, driving, or disassembling pins.
- 3) Always wear gloves, protective clothing and safety shoes with steel toe when working with chains.
- 4) Make absolutely sure that chain is properly supported to prevent uncontrolled movement of chain and parts.
- 5) Chain pressers and breaking tools are recommended to be in good working order and to be used according to instructions.
- 6) Avoid plating or welding assembled chains or components.
- 7) Never repair damaged chains by replacing only the component parts.
- 8) Damaged chain may be yielded and therefore should not be reworked.

Maintenance Check List

Inspect on regularly scheduled basis for worn, damaged or broken parts, possible interference by other systems components, and proper lubrication.

Normal maintenance procedures can prevent most of the conditions described below.

Carefully inspect roller chain drives on the same schedule as associated equipment.

Sprocket Misalignment

Wear on the sides of sprocket teeth generally indicates improper installation of sprockets and/or shafts. If shafts are out of parallel or not in the same plane, non-symmetrical wear will appear on sprockets or chain rollers.

After proper alignment is made retighten set screws in sprocket hubs.

Chain wear and Elongation

Normal wear will cause some increase in chain length. However, if a sudden increase in elongation occurs, look for severe wear on the tips of sprocket teeth. This may be caused by any of the following: excessive loading or shock loading, displacement and/or wear in bearings, displacement of take-up, or under-designed drives.

Excessive elongation may be an indication that chain and/or sprockets should be replaced.

Before replacing chain or sprockets, recalculate initial drive design. Check chain tension if there is too much accumulated slack in the drive.

Broken Chain Parts

Generally caused by an overloaded drive; extreme misalignment; excessive elongation causing chain to jump sprocket teeth; heavy shock; improper drive design geometry; foreign objects. Recalculate initial drive design and make necessary correction. Inspect sprockets and shafts for proper alignment or looseness.

Link Plate Wear

Wear on inside of the link plates and on one side of sprocket teeth may be caused by a misalignment of sprockets.

Realign sprockets and shafts. Inspect chain carefully, readjust chain properly or replace.

Removing Chain

Turn the drive until a connecting link is fully engaged with one of the sprockets so as to relieve the tension on the connecting pin.

The connecting link may then be removed.

Excessive Noise

Can be caused by broken links and chain rollers, extreme misalignment, elongation, chain jumping sprocket teeth, loose sprockets, broken teeth, accumulation of dirt packed into the chain or sprockets teeth, interference by foreign objects, contacting a fixed object.

Check for worn broken or missing parts. Check alignment of shafts and/or sprockets.

Lubrication

On slow speed drives, where manual lubrication is used, if drip lubrication is used check for adequate oil flow and proper application to the chain.

With bath or pump lubrication, check oil level and add oil if needed. Check oil for contamination and change oil if needed.

If pump lubrication is used, check each orifice to be sure it is clear and is directing oil onto the chain properly.

Recommended Replacement

Measure the chain wear elongation and if elongation exceeds functional limits or is greater than 1.5% (0.18 inch in one foot) replace the entire chain.

Do not connect a new section of chain to a worn chain because it may run roughly and damage the drive. Do not continue to run a chain worn beyond

3% elongation because the chain will not engage the sprockets properly and it may damage the sprockets.

Cutting Riveted Chain

The two pins of a pin link must be driven out of the link plate. Strike the pins alternately to avoid distortion of the roller link plates as well as the plates of the adjacent links.

Chain cutting tools can also be used. Follow their instruction carefully.

Inserting New Links

Insert only on new roller chain. Pitch variance between a new link and an old link, especially one which is elongated due to wear, will cause shock when the new link engages the sprockets.

Installing New Chain

Chain and/or related parts should be visually inspected for damage, which could have occurred during shipping prior to installation.

Never install new chain on worn sprockets as this will permanently damage chain. With new chain and sprockets installed, check for proper and sprockets installed, check for proper tension and alignment.

ZEXUS CHAIN Co., Ltd.

Head Office

Shin-Kokusai Building F8,
4-1, Marunouchi 3-Chome,
Chiyoda-ku, Tokyo 100-0005
Japan
Phone: +81-3-4214-1921
Facsimile No: +81-3-3438-1076

<https://www.zexuschain.com/en/>
Email:kokusai@zexuschain.com

Shanghai Representative Office

Rm 508, Block 10 1988 Gong He Xin Road,
Zhabei District, Shanghai 200072
China
Phone: (021)3387-0106
Facsimile No: (021)3387-0176

MAXCO Chain Ltd.

1245 Kennestone Circle,
Marietta, GA 30066,
U.S.A.
Phone: (770)424-9350
Facsimile No: (770)424-9145